



PC/104

Embedded PC Modules

CPC310

CPU MODULE

User Manual

Revision 0.2

February 2018



The product described in this manual is compliant with all related CE standards.

Product Title: **CPC310**
Document name: **CPC310 User Manual**
Manual version: 0.2
Copyright © 2018 Fastwel Co. Ltd. All rights reserved.

Revision Record

| Revision No. | Brief description of changes | Board index | Revision date |
|--------------|---------------------------------------|-------------|---------------|
| 0.1 | Initial version of CPC310 User Manual | CPC310 | May 2016 |
| 0.2 | Compliance assessment | CPC310 | February 2018 |

Contact information

| | Fastwel Co. Ltd | Fastwel LLC |
|----------|----------------------------------------------------------------|------------------------------------------------------------------------------------|
| Address: | 108 Profsoyuznaya st., Moscow 117437, Russian Federation | 4660 La Jolla Village Dr, Suite 100, San Diego, California 92122-1249 USA |
| Tel.: | +7 (495) 232-1681 | Tel.: +1 (858) 488-3663 |
| Fax: | +7 (495) 232-1654 | |
| E-mail: | info@fastwel.com | E-mail: info@fastwel.com |
| Web: | http://www.fastwel.com/ | |

TABLE OF CONTENTS

| | |
|----------------------------------------------------------------------|-----------|
| <i>Trademarks</i> | 7 |
| <i>Ownership Rights</i> | 7 |
| <i>General Board Operation Rules</i> | 8 |
| TRANSPORTATION, UNPACKING AND STORAGE | 9 |
| <i>Transportation</i> | 9 |
| <i>Unpacking</i> | 9 |
| <i>Storage</i> | 10 |
| MANUFACTURER'S WAARRANTY | 11 |
| <i>Warranty Liabilities</i> | 11 |
| <i>Liability Limitation Right</i> | 11 |
| <i>Warranty Period</i> | 11 |
| <i>Limitation of warranty liabilities</i> | 11 |
| <i>Returning a product for repair</i> | 12 |
| 1. INTRODUCTION | 13 |
| 1.1. <i>Purpose</i> | 13 |
| 1.2. <i>Versions, delivery checklist, ordering information</i> | 13 |
| 2. SPECIFICATIONS | 16 |
| 2.1 <i>Functional structure</i> | 16 |
| 2.2 <i>Power supply</i> | 17 |
| 2.3 <i>Operation conditions</i> | 18 |
| 2.4 <i>Mechanical features</i> | 18 |
| 2.5 <i>Module dimensions</i> | 18 |
| 2.6 <i>MTBF</i> | 19 |
| 3. STRUCTURE AND OPERATION | 20 |
| 3.1. <i>Module's block diagram</i> | 20 |
| 3.2. <i>Location of module's main components</i> | 21 |
| 3.3. <i>Aspects of functional units operation</i> | 22 |

| | |
|---------------------------------------------------------------------------------------------------|-----------|
| 3.4. Interfaces and connectors | 24 |
| 3.5 LEDs | 41 |
| 3.6 Watchdog timers | 41 |
| 3.7 Module address space | 42 |
| 4. INSTALLATION OF CPB909..... | 44 |
| 5. CPB909 CONFIGURATION..... | 45 |
| 5.1 Selection of power supply voltage for the buffers on PCI bus for PC/104-Plus modules | 45 |
| 5.2 Clearing CMOS factory settings..... | 45 |
| 5.3 BIOS update | 46 |
| 6. CPC308 PROGRAMMING | 47 |
| 6.1. Operation with digital I/O port..... | 47 |
| 6.2. Operation with watchdog timers | 47 |
| 7. BIOS | 48 |
| 7.1. Entering BIOS SETUP | 48 |
| 7.2. Main | 49 |
| 7.3. Advanced..... | 50 |
| 7.4. Chipset | 63 |
| 7.5. Security..... | 70 |
| 7.6. Boot..... | 71 |
| 7.7. Save & Exit | 72 |
| ANNEX B DISCLAIMER..... | 73 |

List of tables

| | |
|-------------------------------------------------------------------------------------|----|
| Table. 1-1: Ordering information | 14 |
| Table. 1-2: Delivery checklist | 14 |
| Table 1-3: Additional accessories | 15 |
| Table 2-1: Requirements to power source parameters | 17 |
| Table 2.2: Weight and size of the module | 18 |
| Table 3-1: Purpose of PC/104-ISA (XS2) connector contacts | 25 |
| Table 3-2: Purpose of PCI/104-PCI (XS1) connector contacts | 27 |
| Table 3-3: Purpose of VGA (XP22) connector contacts | 29 |
| Table 3-4: Purpose of LVDS (XP19, XP14) connector contacts | 29 |
| Table 3-5: Purpose of Audio connector contacts | 30 |
| Table 3-6: Purpose of COM1, COM2 connector contacts (XP15, XP16) | 31 |
| Table 3-7: Purpose of COM3 and COM4 connectors contacts (XP20, XP21) | 32 |
| Table 3-8: Purpose of LPT connector contacts (XP6) | 34 |
| Table 3-9: Purposes of contacts of USB1,2, USB3,4 connectors (XP2, XP1)..... | 35 |
| Table 3-10: Purpose of contacts of Gigabit Ethernet connector (XP3)..... | 35 |
| Table 3-11: Purpose of CFast connector's contacts (XS4) | 36 |
| Table 3-12: Purpose of PS/2 connector contacts (XP7)..... | 37 |
| Table 3-13: Purpose of XP5 power connector's contacts | 38 |
| Table 3-14: Purpose of contacts of XP9 digital I/O port connector | 38 |
| Table 3-15: Purpose of connector contacts for connection of external LEDs XP8 | 41 |
| Table 3-16: Purpose of LEDs | 41 |
| Table 3-17: Allocation of memory address space | 42 |
| Table 3-18: Allocation of I/O address space | 42 |
| Table 3-19: Allocation of interrupt lines | 43 |
| Table 6-1: Registers for control the WDT2 watchdog timer | 47 |

List of Figures

| | |
|---------------------------------------------------------------------------------|----|
| Fig. 2-1: Overall and connecting dimensions of the module (top view) | 19 |
| Fig. 2-2: Overall dimensions of the module (side view) | 19 |
| Fig. 3-1: Module block diagram | 20 |
| Fig. 3-2: Location of connectors and main components on the TOP side | 21 |
| Fig. 3-3: Location of connectors and main components on the BOTTOM side | 22 |
| Fig. 3-4: PC/104-ISA (XS2) connector | 25 |
| Fig. 3-5: Contacts of PCI-104 (XS1) connector | 27 |
| Fig. 3-6: VGA CRT (XP22) connector | 28 |
| Fig. 3-7: LVDS (XP19, XP14) connectors | 29 |
| Fig. 3-8: Audio-connector XP17 | 30 |
| Fig. 3-9: Audio-connector XP18 | 30 |
| Fig. 3-10: COM1/COM2 connector (XP15 and XP16) | 31 |
| Fig. 3-11: Connectors of COM3, COM4 ports (XP20, XP21) | 31 |
| Fig. 3-12 Point-to-point connection of two devices using RS 422 interface | 32 |

| | |
|-----------------------------------------------------------------------------------------|----|
| Fig. 3-13: Combining several devices via RS 485 interface | 33 |
| Fig. 3-14: LPT connector (XP6) | 34 |
| Fig. 3-15: USB1,2, USB3,4 connectors (XP2 and XP1) | 34 |
| Fig. 3-16: Gigabit Ethernet connector (XP3) | 35 |
| Fig. 3-17: CFast XS4 connector | 36 |
| Fig. 3-18: PS/2 connector (XP7) | 37 |
| Fig. 3-19: XP5 power supply connector..... | 38 |
| Fig. 3-20: Connector of XP9 digital I/O port | 38 |
| Fig. 3-21: Optoisolated external reset input XP23..... | 39 |
| Fig. 3-22: Diagram for implementation of module's digital input optical isolation | 39 |
| Fig. 3-23: Reset XP12 connector | 39 |
| Fig. 3-24: Connector Ext. Batt XP13 | 40 |
| Fig. 3-25: Reset XP8 connector | 40 |
| Fig. 3-26: XP8 connector for external LEDs | 41 |
| Fig. 5-1: State of contacts of PCI VIO switch (XP10) | 45 |
| Fig. 7- 1: Screen during the module booting process (POST)..... | 48 |
| Fig. 7- 2: Screen of the "Main" menu tab..... | 49 |
| Fig. 7- 3: Screen of the "Advanced" menu tab..... | 50 |
| Fig. 7- 4: Screen of the "ACPI Settings" submenu..... | 51 |
| Fig. 7- 5: Screen of the "Onboard Device Configuration" submenu..... | 52 |
| Fig. 7- 6: Screen of the "ISA Bridge Settings" submenu..... | 53 |
| Fig. 7- 7: Screen of the "SCH3114x Super IO Configuration" submenu..... | 54 |
| Fig. 7- 8: Screen of the "Hardware Monitor" submenu..... | 55 |
| Fig. 7- 9: Screen of the "Serial Port Console Redirection" submenu..... | 56 |
| Fig. 7- 10: Screen of the "Serial Port Console Redirection" submenu..... | 57 |
| Fig. 7- 11: Screen of the "SATA Configuration" submenu..... | 58 |
| Fig. 7- 12: Screen of the "Miscellaneous Configuration" submenu..... | 59 |
| Fig. 7- 13: Screen of the "LPSS & SCC Configuration" submenu..... | 60 |
| Fig. 7- 14: Screen of the "CSM Configuration" submenu..... | 61 |
| Fig. 7- 15: Screen of the "USB Configuration" submenu..... | 62 |
| Fig. 7- 16: Screen of the "Chipset" menu tab..... | 63 |
| Fig. 7- 17: Screen of the "North Bridge" submenu..... | 64 |
| Fig. 7- 18: Screen of the "Intel IGD Configuration" submenu..... | 65 |
| Fig. 7- 19: Screen of the "LVDS Control" submenu..... | 66 |
| Fig. 7- 20: Screen of the "South Bridge" submenu..... | 67 |
| Fig. 7- 21: Screen of the "Azalia HD Audio" submenu..... | 68 |
| Fig. 7- 22: Screen of the "USB Configuration" submenu..... | 69 |
| Fig. 7- 23: Screen of the "Security" tab..... | 70 |
| Fig. 7- 24: Screen of the "Boot" menu tab..... | 71 |
| Fig. 7- 25: Screen of the "Save & Exit" menu tab..... | 72 |

All information in this document is provided for reference only, with no warranty of its suitability for any specific purpose. This information has been thoroughly checked and is believed to be entirely reliable and consistent with the product that it describes. However, Fastwel accepts no responsibility for inaccuracies, omissions or their consequences, as well as liability arising from the use or application of any product or example described in this document.

Fastwel Co. Ltd. reserves the right to change, modify, and improve this document or the products described in it, at Fastwel's discretion without further notice. Software described in this document is provided on an "as is" basis without warranty. Fastwel assumes no liability for consequential or incidental damages originated by the use of this software.

This document contains information, which is property of Fastwel Co. Ltd. It is not allowed to reproduce it or transmit by any means, to translate the document or to convert it to any electronic form in full or in parts without antecedent written approval of Fastwel Co. Ltd. or one of its officially authorized agents.

Fastwel and Fastwel logo are trademarks owned by Fastwel Co. Ltd., Moscow, Russian Federation. Ethernet is a registered trademark of Xerox Corporation. IEEE is a registered trademark of the Institute of Electrical and Electronics Engineers Inc. Intel is a trademark of Intel Corporation. Pentium M and Celeron M are trademarks of Intel Corporation. Microsoft is a trademark of the Microsoft corporation. In addition, this document may include names, company logos and trademarks, which are registered trademarks and, therefore, are property of their respective owners.

Fastwel welcomes suggestions, remarks and proposals regarding the form and the content of this Manual.

Trademarks

"Fastwel" logotype is a trademark belonging to Fastwel Group Co. Ltd., Moscow, Russian Federation.

Besides, this document may contain names, corporate logotypes and trademarks being registered trademarks; consequently, property rights to them belong to their respective legitimate owners.

Ownership Rights

This document contains information being the property of Fastwel Group Co. Ltd. It can neither be copied nor transferred with the utilization of known media nor be stored in data storage and search systems without the prior written authorization of Fastwel Group Co. Ltd. To our best knowledge, the data in this document does not contain errors. However, Fastwel Group Co. Ltd cannot take responsibility for any inaccuracies and their consequences, as well as responsibility arising as a result of utilization or application of any diagram, product or example cited in this document. Fastwel Group Co. Ltd reserves the right to alter and update both this document and the product presented therein at its own discretion without additional notification.

General Board Operation Rules

- To keep the warranty, the product should not be altered or revised in any way. Any alterations or improvements not authorized by Fastwel LLC, except for those specified in this document or obtained from the technical support department of Fastwel LLC as a set of instructions for their implementation, cancel the warranty.
- This device should be installed and connected only to the systems, meeting all the necessary technical and climatic requirements. This above is also true of the operating temperature range of a particular version of the board.
- While performing all the required operations for installation and adjustment, please follow the instructions specified only in this document.
- Keep the original package for subsequent storage of the device and transportation in the warranty event. If it is necessary to transport or store the board, please pack it the same way as it was packed upon delivery.
- Exercise special care when unpacking and handling the device. Act in accordance with the instructions given in the paragraph above.

TRANSPORTATION, UNPACKING AND STORAGE

Transportation

The module should be transported in a separate packaging box (transport packaging) of the manufacturing facility, which consists of an individual antistatic bag and a cardboard box, in the closed transport (automobile, railway, air transportation in heated and pressurized compartments) in storage conditions 5 defined in the GOST standard 15150-69 (IEC 721-2-1 standard) or in storage conditions 3 during sea transportation.

It is possible to transport modules, packaged in individual antistatic packages, in multiple packaging (transport packaging) of the manufacturing facility.

The packaged modules should be transported in accordance with the shipping rules, operating with this particular type of transport.

During handling and transportation operations, the packaged modules should not undergo sharp pounding, falls, shocks and exposure to atmospheric precipitation. The packaged modules should be stored in a carrier vehicle in such a manner which will prevent their moving.

Unpacking

Prior to unpacking, before transportation at subzero temperature of ambient air the modules should be kept within 6 hours under storage conditions 1 defined in the GOST standard 15150-69 (IEC 721-2-1 standard).

It is prohibited to place the packaged module close to the heat source, prior to unpacking.

While unpacking, it is required to comply with all safety precautions, which ensure its safety, as well as marketable condition of consumer packaging of the manufacturing company.

At the time of unpacking it is required to check the module that it has no external mechanical damages after transportation.

Storage

Module storage conditions for group 1 are defined in the GOST standard 15150-69 (IEC 721-2-1 standard).

MANUFACTURER'S WAARRANTY

Warranty Liabilities

- The Manufacturer hereby guarantees the product conformity with the requirements of the TY 4013-006-52415667-05 technical conditions provided that the Consumer complies with the operating, storage, transportation and installation conditions and procedures, specified by the accompanying documents.
- The Manufacturer hereby guarantees that the products supplied thereby are free from defects in workmanship and materials, provided operation and maintenance norms were observed during the currently established warranty period. The Manufacturer's obligation under this warranty is to repair or replace free of charge any defective electronic component being a part of a returned product.
- Products that broke down through the Manufacturer's fault during the warranty period will be repaired free of charge. Otherwise the Consumer will be invoiced as per the current labor remuneration rates and expendable materials cost

Liability Limitation Right

- The Manufacturer shall not be liable for the damage inflicted to the Consumer's property because of the product breakdown in the process of its utilization.

Warranty Period

- The warranty period for the products made by Fastwel LLC is 36 months since the sale date (unless otherwise provided by the supply contract).
- The warranty period for the custom-made products is 60 months since the sale date (unless otherwise provided by the supply contract).

Limitation of warranty liabilities

The above warranty liabilities shall not be applied:

- To the products (including software), which were repaired or were amended by the employees, that do not represent the manufacturer. Exceptions are the cases where the customer has made repairs or made amendments to the devices in the strict compliance with instructions, preliminary agreed and approved by the manufacturer in writing;

- To the products, broken down due to unacceptable polarity reversal (to the opposite sign) of the power supply, improper operation, transportation, storage, installation, mounting or accident.

Returning a product for repair

1. Apply to Fastwel company or to any of the Fastwel's official representatives for the Product Return Authorization.
2. Attach a failure inspection report with a product to be returned in the form, accepted by the Manufacturer, with a description of the failure circumstances and symptoms.
3. Carefully package the product in the antistatic bag, in which the product had been supplied. Failure to package in antistatic material will VOID all warranties. Then package the product in a safe container for shipping.
4. The customer pays for shipping the product to Fastwel or to an official Fastwel representative or dealer

1 INTRODUCTION

1.1 Purpose

This User Manual (hereinafter referred to as the User Manual) is designed for providing you with valuable information on the device, principle of its operation and other data, required for commissioning, intended use and maintenance of CPC310 CPU Module (hereinafter referred to as the “module”).

The module is PC/104-Plus single-board computer and is designed for embedded applications that require high-performance and low power consumption.

The module contains: CFast connector, 2x Ethernet channels, 4x USB ports, 1x Serial ATA port, 4x serial ports, NAND Flash drive.

Extension of module’s functional capabilities is possible when connecting additional modules of PC/104, PC/104-Plus, PCI-104 formats.

The module is supplied with the installed operating system (hereinafter referred to as the OS) FreeDOS and is compatible with the following operating systems: QNX, Windows Embedded Standard 7, Linux.

The User Manual contains guidelines for proper and safe installation, module switching-on and configuring, connection and interaction with extension modules or external devices.

The manual also covers issues related to running, debugging and use of programs from among base and service software (hereinafter referred to as the “software”).

For safe and proper operation of the module within the specified life period, you’ll need first read and understand the contents of this User Manual.



WARNING: USING THE MODULE WITHOUT OBSERVING SAFETY REQUIREMENTS, OPERATION AND APPLICATION NOTES IS NOT ALLOWED!



ATTENTION: MODULE CONTAINS COMPONENTS, SENSITIVE TO ELECTROSTATIC DISCHARGE!

1.2 Versions, delivery checklist, ordering information

1.2.1 Versions, ordering information

Module versions and their ordering names (ordering information) are specified in the Table 1.1 below:

Table 1-1: Ordering information

| Name | Reference name | Ordering name | Note |
|---------------------------------------------------------------------------------------------------------------------------------------------------------------------------------------------------------------------------------------------------------------------------------------------------------------------------------------------------------------------------------------------------------------|----------------|--------------------------------|---------------------------------------------------------------------------------------------------------------------------------------------------------------------------|
| CPC310 CPU Module | CPC310 | CPC310-01 ¹⁾ | Intel Atom E3825 /4GB DDR3 RAM ECC/ 8GB NAND Flash/ CFast/ SATA/ Digital IO/ 2x Ethernet/ 4x USB 2.0/ 2x RS232/ 2x RS422/485/ VGA/ 2xLVDS/-40...+75 °C |
| | | CPC310-02 ²⁾ | Intel Atom E3815 /2GB DDR3 RAM ECC/ 4GB NAND Flash/ CFast/ SATA/ Digital IO/ 2x Ethernet/ 4x USB 2.0/ 2x RS232/ 2x RS422/485/ VGA/ 2xLVDS/-40...+85 °C |
| | | CPC310-03 ³⁾ | Intel Atom E3825 /4GB DDR3 RAM ECC/ 4GB NAND Flash/ CFast/ SATA/ Digital IO/ 2x Ethernet/ 4x USB 2.0/ 2x RS232/ 2x RS422/485/ VGA/ 2xLVDS/-40...+75 °C |
| | | CPC310-04 ³⁾ | Intel Atom E3815 /2GB DDR3 RAM ECC/ 2GB NAND Flash/ CFast/ SATA/ Digital IO/ 2x Ethernet/ 4x USB 2.0/ 2x RS232/ 2x RS422/485/ VGA/ 2xLVDS /-40...+85 °C |
| | | CPC310-xx\Coated ⁴⁾ | Option with the conformal coating |
| <p>1) Module contains a complete set of integrated interfaces and functional elements. 2) Module differs from CPC310-01 by the installed single-core CPU Intel Atom E3815, RAM 2GB, NAND Flash 4GB and operating temperature range from – 40 to +85°C. 3) CPC310-03 and CPC310-04 modules differ from CPC310-01 and CPC310-02 by lack of NAND Flash. 4) xx – any version: 01,02,03 and 04.</p> | | | |

**Note**

When ordering the device with a conformal coating, suffix “/COATED” will be added.

1.2.2 Delivery checklist

The delivery checklist for all module versions is specified in the Table 1.2 below:

Table 1-2: Delivery checklist

| Ordering name | Decimal number | Description |
|------------------------------------------------------|--------------------------------------------------------------------------------------|----------------------------------------------------------------------------------|
| CPC310-01, CPC310-02, CPC310-03, CPC310-04. | IMES.467444.076, IMES.467444.076-01, IMES.467444.076-02, IMES.467444.076-03 | CPC310 CPU Module |
| ACS00023-04 | FAP1.685611.082-04 | Cable adaptor (DB9M – IDC10) for the connection to XP15, XP16 (COM1, COM2) |
| ACS00027-02 | IMES.685611.123-02 | Cable adaptor (DB15F – IDC10) for connection of VGA Monitor to |

| | | |
|------------------------|-----------------|--------------------------------------------------------------------|
| | | XP22 |
| ACS00043 | IMES.685611.156 | Cable adaptor for the connection of PS/2 keyboard and mouse to XP7 |
| ACS00057 | IMES.467941.029 | Power outlet with contacts for the connection to XP5 |
| - | - | Jumper 2 mm |
| Screw DIN7985-M3x6-A2 | - | Screws (4 pcs), from the installation kit |
| Nut DIN985-M3-A2 | - | Nuts (4 pcs) from among the installation kit |
| Washer DIN125-3,2-A2 | - | Washers (4 pcs) from among the installation kit |
| Washer DIN6798A-3,2-A2 | - | Washers (4 pcs) from among the installation kit |
| Rack WE p/n 971150324 | - | Racks (4 pcs) from among the installation kit |
| - | - | - |
| - | IMES.421945.065 | Packaging |

1.2.3 Additional accessories

Additional accessories for connection to the module are specified in the Table 1.3 below.

Table 1-3: Additional accessories

| Ordering name | Description |
|---------------|----------------------------------------------------------------------------------------------------------------------------------------------------------------------------------------------------------|
| ACS00031-01 | Installation kit ACS00031-01. The kit contains JST PHR-5 socket and a set of contacts SPH-002T-P0.5S for connection to XP20, XP21, XP17 (COM3, COM4, Audio) of the module. |
| ACS00031-02 | Installation kit ACS00031-02. The kit contains JST PHR-6 socket and a set of contacts SPH-002T-P0.5S for connection to XP7 (KB/Mouse) of the module. |
| ACS00031-03 | Installation kit ACS00031-03. The kit contains JST PHR-2 and a set of contacts SPH-002T-P0.5S for connection to XP12, XP13, XP18, XP23 (Reset, Ext BAT, Mic In, Opto Reset) of the module. |
| ACS00037 | Installation kit ACS00037. The kit contains Hirose DF13-20DS-1.25C socket and a set of contacts DF13-2630SCF for connection to XP19, XP14 (LVDS1, LVDS2) of the module |
| ACS00040-03 | Installation kit ACS00040-03. The kit contains Leotronics 2040-3262 socket for connection to X36 (LPT) of the module. |
| ACS00064 | Installation kit ACS00064. The kit contains Amphenol FCI 89947-710LF socket for slotting the flat-ribbon cable for connection to XP15, XP16, XP22 (COM1, COM2, VGA) of the module. |
| ACS00064-01 | Installation kit ACS00064-01. The kit contains Amphenol FCI 10073599-010LF socket with a latch and a set of contacts 77138-101LF for the connection to XP15, XP16, XP22 (COM1, COM2, VGA) of the module. |
| ACS00064-02 | Installation kit ACS00064-02. The kit contains Amphenol FCI 89947-720LF socket for slotting the flat-ribbon cable for connection to XP3 (2xGBE) of the module. |
| ACS00064-03 | Installation kit ACS00064-03. The kit contains Amphenol FCI 10073599-020LF socket with a latch and a set of contacts 77138-101LF for the connection to XP3 (2xGBE) of the module. |



NOTE: ADDITIONAL ACCESSORIES FOR CONNECTION TO THE MODULE ARE NOT INCLUDED INTO THE SCOPE OF DELIVERY AND ARE OFFERED AS AN OPTION.

2 Specifications

2.1 Functional structure

The module contains the following main functional elements:

- CPU: Intel Atom E3825 or Intel Atom E3815 (for CPC310-01, CPC310-03) or Intel Atom E3815 (for CPC310-02, CPC310-04):
 - 2x 32-/64-bit x86 cores (for E3825),
 - single 32-/64-bit x86 core (for E3815),
 - 64-bit memory bus,
 - L1 cache – 32 KB for program area, 24 KB for data area,
 - L2 cache – 1 MB,
 - support of SSE4.1, SSE4.2
 - support of Intel SpeedStep technology;
- DDR3 SDRAM 1066 MHz with ECC (soldered onboard) – 4 GB (for CPC310-01, CPC310-03);
- DDR3 SDRAM 1066 MHz with ECC (soldered onboard) – 2 GB (for CPC310-02, CPC310-04);
- Flash BIOS:
 - 64 Mb,
 - modifiable within the system;
- SATA interface (switched with CFast connector) routed to the StackPC connector:
 - support of SATA II specification;
- NAND Flash drive (soldered and connected to SATA interface) – 8 GB (for CPC310-01):
 - support of SATA II specification
- NAND Flash drive (soldered and connected to SATA interface) – 4 GB (for CPC310-02):
 - support of SATA II specification;
- Connector for CFast (switched with SATA interface):
 - support of SATA II specification;
- PCI bus:
 - support of v.3.0 specification,
 - 32-bit / 33MHz;
 - Connection of up to 3x bus master devices;
- SMBUS:
 - support of v.2.0 specification,
 - rate of up to 100 Kb/sec;
- Video controller:
 - 2D/3D accelerator,
 - VGA output (resolution of up to 2560x1600, 60 Hz),
 - 2x LVDS ports, resolution of up to 1600x1200, 60Hz, 18/24 bit;
- Two Ethernet controllers 10/100/1000 Mb;
- USB ports:
 - connection of up to 4x devices,
 - support of USB 1.1, USB 2.0 specifications,

- support of OS booting from USB drive;
- Serial ports:
 - COM1, COM2: RS-232, 9-wire (full), with possibility of console I/O, with data exchange rate of no more than – 115,2 Kb/sec,
 - COM3, COM4: RS-422/485, with galvanic isolation (breakdown voltage of 500 V), with data exchange rate of no more than – 921 Kb/sec;
- Universal parallel port (with support of EPP, ECP modes);
- HD Audio controller:
 - linear stereo input/output,
 - input for microphone connection;
- PS/2 keyboard and mouse port;
- Digital I/O port:
 - 8x separately programmable I/O lines;
- Opto-isolated input of external reset/interrupt:
 - Insulation breakdown voltage – 500 V;
- Real-Time Clock (RTC);
- Serial FRAM (for storing user configuration);
- Two watchdog timers (WDT):
 - WDT1 – with fixed actuation interval – 1.6 sec,
 - WDT2 – with the programmable actuation interval – from 1 sec to 255 min;

Module is compatible with the following OS: FreeDOS, QNX, Windows Embedded Standard 7, Linux.

2.2 Power supply

Module's power supply should correspond to the requirements, specified in the Table 2.1. The module can be fed with power via a power supply connector (XP5), as well as via PC/104 bus connector. Maximum current consumption value is 2A for CPC310-01, CPC310-03 and 1.6 A for CPC310-02 and CPC310-04 modules, exclusive of connected external devices.

Table 2-1: Requirements to power source parameters

| Output voltage, V | Rated load current, A | Output voltage buildup time to the level of +4,75 V, ms |
|---------------------|-----------------------|---------------------------------------------------------|
| From +4,75 to +5,25 | 4 | No more than 10 |



IT IS PROHIBITED TO RESTART THE MODULE LESS THAN 5 SECONDS AFTER ITS SHUTDOWN.

2.3 Operation conditions

The module should be used under the following operation conditions:

– Operating temperature range:

CPC310-01, CPC310-03 – from - 40 to + 75 °C,

CPC310-02, CPC310-04 – from - 40 to + 85 °C,

The modules are resistant to ambient temperature changes within the specified temperature range, with the relative humidity of up to 80% without condensation.

2.4 Mechanical features

The module corresponds to the following mechanical features:

- Resistance to sinusoidal vibration within the range of frequencies: from 10 to 500 Hz, acceleration amplitude no more than – 5g;

– Single shock resistance, peak acceleration is no more than – 100 g,

– Multiple shock resistance (number of shocks: 1000), peak acceleration is no more than – 50 g.

2.5 Module dimensions

Weight and size values for module's versions are specified in the Table 2.2 below:

Table 2.2: Weight and size of the module

| Module | Weight in kg, no more than | Packaged weight in kg, no more than | Dimensions in mm, no more than | Package dimensions in mm |
|--------------------------------------------------|----------------------------|-------------------------------------|--------------------------------|--------------------------|
| CPC310-01 CPC310-02 CPC310-03 CPC310-04 | 0,200 ¹⁾ | 0,354±0,05 | 116,0 x 96,0 x 24,5 | 230 x 155 x 45 |
| 1) Not including the weight of CFast device. | | | | |

General overall and connecting dimensions of the module are shown in Figure 2.1 and Figure 2.2 below.

Fig. 2-1: Overall and connecting dimensions of the module (top view)

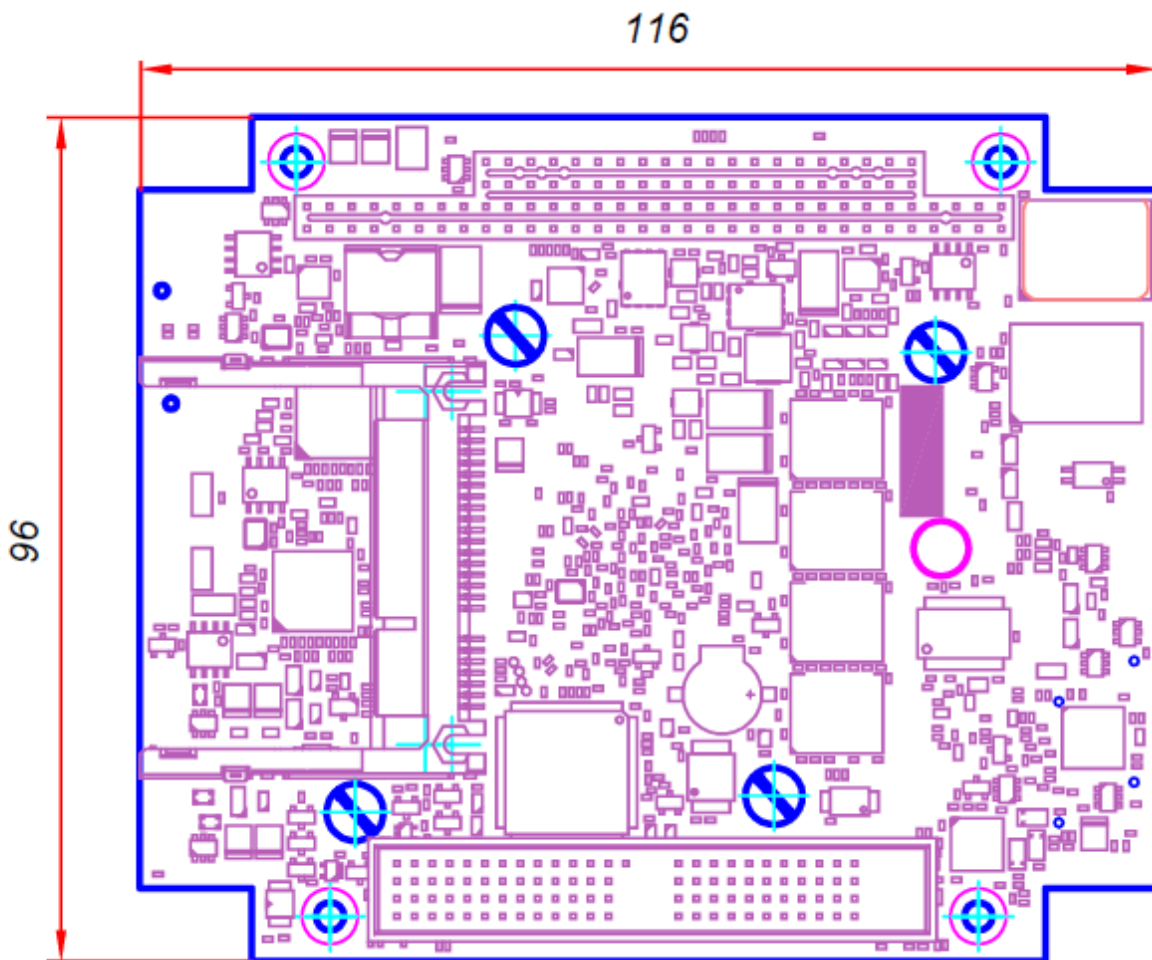
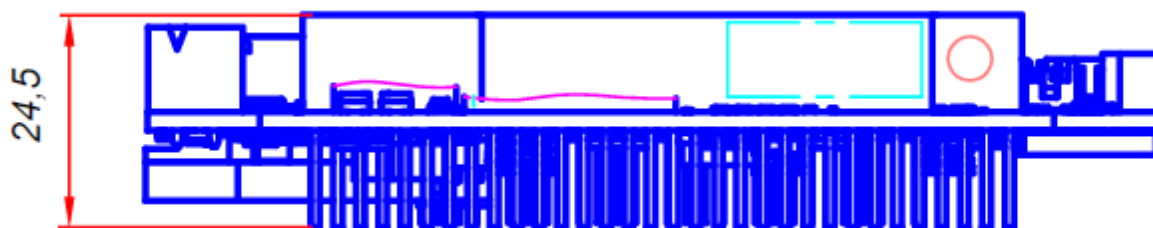

Fig. 2-2: Overall dimensions of the module (side view)



2.6 MTBF

The MTBF value for the module is – 150 000 hours.



Note

This MTBF value is calculated using the Telcordia Issue 1 model, Method I Case 3, for continuous operation when located on the ground under conditions corresponding to the moderately cold climate 4 in accordance with the GOST standard 15150-69, at the ambient temperature of + 30°C.

3 Structure and operation

3.1 Module's block diagram

Module's block diagram is shown in Figure 3-1 below:

Fig. 3-1: Module block diagram

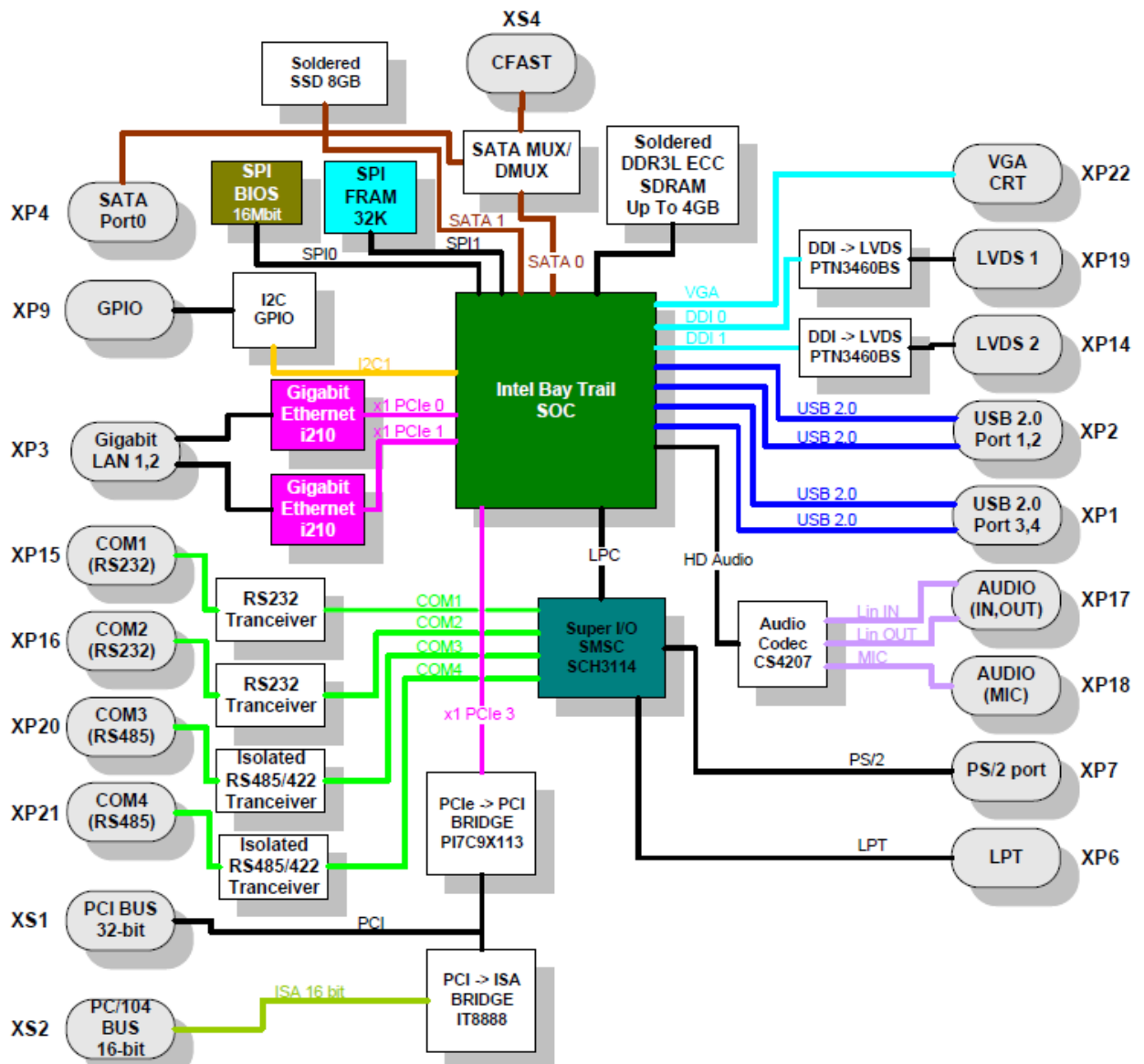

The module' block diagram shows main functional units:

- Intel Atom E3825 and Intel Atom E3815 (for CPC310-01, CPC310-03) CPUs (for CPC310-02, CPC310-04);
- DDR3 SDRAM (4 GB for CPC310-01, CPC310-03 and 2 GB for CPC310-02, CPC310-04);
- Flash BIOS (64 Mb);
- NAND Flash drive (8 GB for CPC310-01 and 4 GB for CPC310-02);

- VGA display port (**XP22**);
- Connectors for TFT panels with LVDS interface (**XP19, XP14**);
- Connector for CFast drive (**XS4**);
- 2x Ethernet 10/100/1000 Mb channels (**XP3**);
- 4x USB 2.0 ports (**XP2, XP1**);
- Serial ports COM1 (RS232) (**XP15**), COM2 (RS 232) (**XP16**), COM3 (RS422/485) (**XP20**), COM4 (RS 422/485) (**XP21**);
- LPT parallel port (**XP6**);
- PS/2 keyboard/mouse port (**XP7**);
- Digital I/O port (**XP9**);
- HD audio controller with linear I/O and MIC connectors (**XP17 and XP18**);
- PC/104 ISA connector (**XS2**);
- PCI-104 connector PCI bus 32 bit 33 MHz (**XS1**);
- Serial FRAM (for storing user configuration).

Technical features of main functional units of the module are specified in subsection 2.1 of this Manual.

3.2 Location of module's main components

Location of main components, their corresponding connectors, as well as commutator bars from the side of components (TOP) and from the assembly side (BOTTOM) of the module is shown in Fig. 3-2 and Fig. 3-3.

Location of jumpers in commutator bars of the module is also by default shown in Fig. 3-2.

Fig. 3-2: Location of connectors and main components on the TOP side

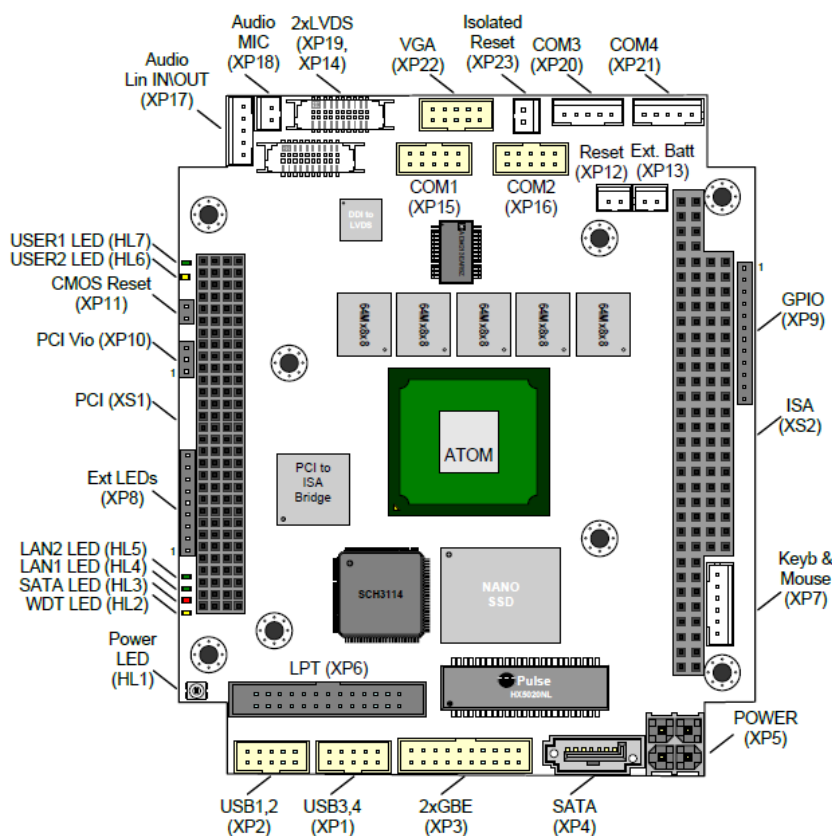
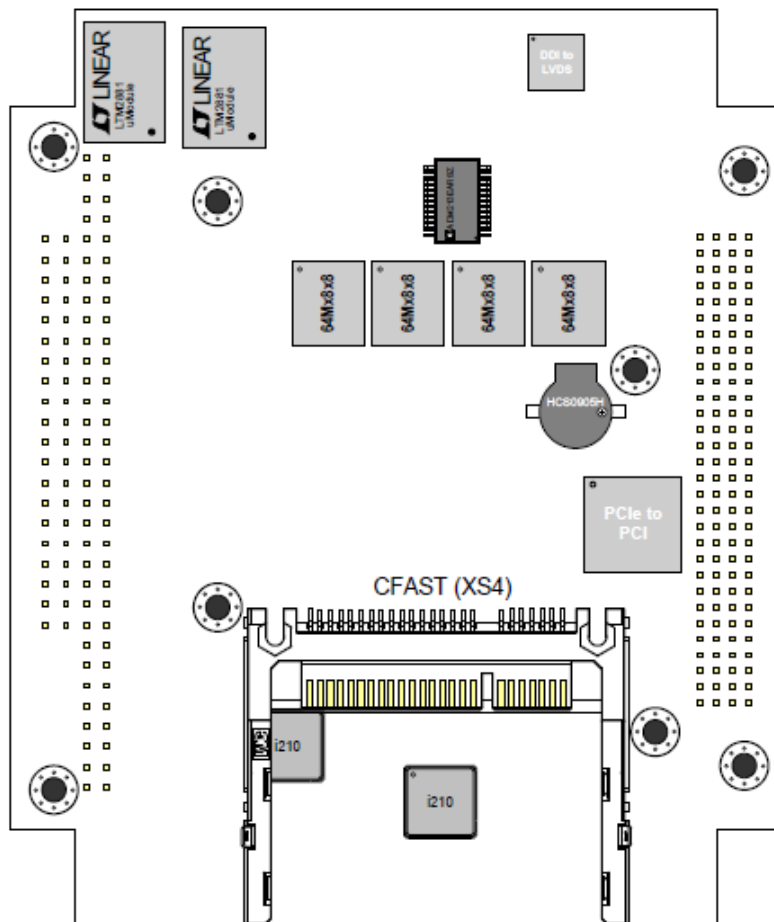

Fig. 3-3: Location of connectors and main components on the BOTTOM side



3.3 Aspects of functional units operation

- **Intel Atom E38xx**

32-bit Intel microprocessor with low power consumption (TDP lower than 6 W for dual core and lower than 10 W for quad core processor). Industrial operating temperature range: from - 40 °C to +85 °C.

It represents a single-chip solution, combining up to four improved Intel Atom cores, 64-bit memory controller DDR3 SDRAM (up to 4 GB, 1066) with ECC support, modern graphics subsystem with 2D/3D acceleration Gen7 (video processor frequency is up to 700 MHz), I/O subsystem (PCI-E, USB, SATA) and a set of standard hardware support of the platform (RTC, UART, Timers, GPIO etc.). The CPU has the video coding hardware support (MPEG-2 / H.263 / H.264), as well as hardware acceleration of video decoding (H.264 / MPEG2 / MPEG4 / VC1 / WMV9).

The CPU is implemented in FCBGA-1170 enclosure, with the following dimensions: 27 x 25 x 0.6 mm.

Intel Atom E3825 – two 32-/64-bit x86 cores with low power consumption (~6 W), 64-bit memory bus, L1 cache – 32 KB for program area, 24 KB for data area, L2 cache – 1 MB, support of SSE4.1, SSE4.2, support of the Intel SpeedStep technology.

Intel Atom E3815 – single 32-/64-bit x86 core with low power consumption (~5 W), 64-bit memory bus, L1 cache – 32 KB for program area, 24 KB for data area, L2 cache – 1 MB, support of SSE4.1, SSE4.2, support of the Intel SpeedStep technology.

- **DDR3 SDRAM**

The board is equipped with 9 (soldered) microchips DDR3 SDRAM 1066 MHz with a total of up to 4 GB (for CPC310-01, CPC310-03) and 2 GB (for CPC310-02, CPC310-04). Operation mode – single-channel, with ECC support.

- **BIOS**

For storing the main (working) copy of BIOS, microchip SPI-Flash 64 Mb is used. BIOS loading from the LPC bus (via StackPC connector) is supported.

- **RTC, CMOS**

Real-time clock is integrated into the CPU. Operating capacity of the clock when the power is off is ensured by the lithium battery, which is connected to the module via XP13 connector. CMOS settings are stored in the SPI Flash non-volatile memory.

- **SPI FRAM**

The module has non-volatile memory 32 KB (Ramtron, FM25V02), which could be used for storing the user data.

- **PCI-E 2.0 ports**

3x ports PCI-E 2.0 with the bandwidth capacity up to 5 Gb/sec.

- **SATA ports**

1 SATA port is routed to the StackPC connector (this port is switched with the CFast drive connector). Support of SATA I, SATA II specifications (up to 3 Gb/sec).

- **NAND Flash Disk¹⁾**

The module is equipped with NAND Flash Disk drive, connected to SATA interface (SATA II specification is supported). Data transfer rate reaches up to 116 Mb/sec. (reading) and up to 70 Mb/sec. (writing). The drive volume depends on the module version (8 GB for CPC310-01, 4 GB for CPC310-02).

- **CFast**

The module is equipped with the connector for CFast drive (SATA II specification is supported). This connector is switched with SATA port, which is routed to the StackPC connector.

- **USB 2.0 port**

The board has 4x USB 2.0 channels with support of USB 1.1 and USB 2.0 specifications.

- **Gigabit Ethernet ports**

The module has 2x Gigabit Ethernet channels. Gigabit Ethernet I210 controllers are used.

- **COM1, COM2 ports**

COM1, COM2 – 9-wire RS-232 interface. COM1 is routed to DSUB connector on the board. COM2 is routed to the IDC10 type connector with a contact pitch of 2 mm on the board.

- **COM3, COM4 ports**

COM3, COM4 – galvanic isolated RS-422/485, with the breakdown voltage of up to 500 V.

¹⁾ Not installed on CPC310-03, CPC310-04 modules.

The transmitter control is carried out in automatic mode. Each port is routed to the straight 5-contact connector with a pitch of 2 mm. Matching resistors of interfaces (RS-422/485) can be connected using BIOS SETUP.

- **PS/2 Keyboard & Mouse**

Designed for connecting PS/2 keyboard and mouse to the module, a single-row straight 6-contact connector with a pitch of 2 mm is used.

- **Video ports**

The ports are intended for the connection analog or digital monitor with VGA interfaces, as well as for the connection of matrix with LVDS interface. Support of two-monitor configuration is ensured: clone/extended desktop.

- **Audio ports**

Support is implemented with the use of Audio Codec HD Audio. The board has connectors with signals: linear input, linear output (5-contact connector with a pitch of 2 mm), as well as microphone input (2-contact connector with a pitch of 2 mm).

- **GPIO port (8x I/O channels)**

I2C GPIO microchip is used, interrupt generation over events at input is supported.

- **Watchdog**

The module has two watchdog timers, one (WDT1) is integrated into the supervisor's microchip and has a fixed actuation interval (1.6 sec), another one is integrated into the SIO microchip and has a programmable actuation interval (up to 255 min).

- **Indication**

The module is equipped with the LEDs for indication of module's operating mode (module is ON, sleep mode, StackPC error), indication of SATA drives activity, two controlled user LEDs, as well as the LEDs for indication of state and activity of connection via LAN.

- **Power reset and monitoring**

Microprocessor reset signal is generated from the following sources:
from supervisor during power on;
from the "Reset" button;
from watchdog timers;
from the external signal of isolated reset.

- **Switches (jumpers)**

The board is equipped with the switches of the following functionalities:
"PCI VIO Selector" switch (XP10);
"CMOS Reset" switch (XP11).

3.4 Interfaces and connectors

3.4.1 PC/104-Plus connectors

The module is equipped with standard connectors of PC/104-Plus format, which are used for connecting the module with such devices as analog-to-digital converters, digital I/O modules etc. According to the PC/104-Plus specification, module of such a format includes PC/104-ISA and PC/104-PCI connectors, described below.

3.4.2 PC/104-ISA interface

PC/104-ISA (XS2) interface makes it possible to operate with 8- or 16-bit PC/104 extension modules. For PC/104 bus, 104-pin 0.10" connector (2.54 mm) is used, which is located in the upper side of the module. This connector can be used for transmitting ISA bus signals with a frequency of 8 MHz.

CPC310 supports of up to 4x PC/104 extension modules without additional buffering. Location and purpose of PC/104-ISA connector contacts is given in the Figure 3-4 and Table 3-1 below.

Fig. 3-4: PC/104-ISA (XS2) connector

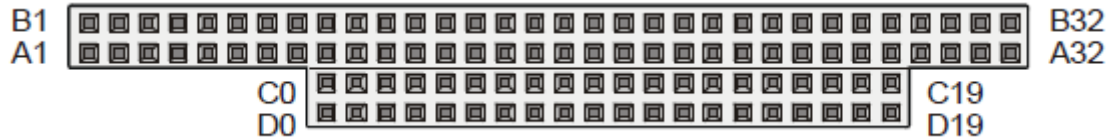

Table 3-1: Purpose of PC/104-ISA (XS2) connector contacts

| Contact | Signal | State | Contact | Signal | State |
|---------|---------|----------------|---------|----------|--------|
| A1 | /IOCHK | - | B1 | GND | Power |
| A2 | SD7 | Input / Output | B2 | RESET | Output |
| A3 | SD8 | Input/ Output | B3 | +5V | Power |
| A4 | SD5 | Input / Output | B4 | IRQ9 | Input |
| A5 | SD4 | Input / Output | B5 | -5V | Power |
| A6 | SD3 | Input / Output | B6 | DRQ2 | Input |
| A7 | SD2 | Input / Output | B7 | -12V | Power |
| A8 | SD1 | Input / Output | B8 | 0WS | Input |
| A9 | SD0 | Input / Output | B9 | +12V | Power |
| A10 | IOCHRDY | Input | B10 | GND | Power |
| A11 | AEN | Output | B11 | /SMEMW | Output |
| A12 | SA19 | Output | B12 | /SMEMR | Output |
| A13 | SA18 | Output | B13 | /IOW | Output |
| A14 | SA17 | Output | B14 | /IOR | Output |
| A15 | SA16 | Output | B15 | /DACK3 | Output |
| A16 | SA15 | Output | B16 | DRQ3 | Input |
| A17 | SA14 | Output | B17 | /DACK1 | Output |
| A18 | SA13 | Output | B18 | DRQ1 | Input |
| A19 | SA12 | Output | B19 | /REFRESH | Output |
| A20 | SA11 | Output | B20 | BCLK | Output |
| A21 | SA10 | Output | B21 | IRQ7 | Input |
| A22 | SA9 | Output | B22 | IRQ6 | Input |
| A23 | SA8 | Output | B23 | IRQ5 | Input |
| A24 | SA7 | Output | B24 | IRQ4 | Input |
| A25 | SA6 | Output | B25 | IRQ3 | Input |
| A26 | SA5 | Output | B26 | /DACK2 | Output |
| A27 | SA4 | Output | B27 | TC | Output |
| A28 | SA3 | Output | B28 | BALE | Output |
| A29 | SA2 | Output | B29 | +5V | Power |

| Contact | Signal | State | Contact | Signal | State |
|---------|--------|----------------|---------|----------|--------|
| A30 | SA1 | Output | B30 | OSC | Output |
| A31 | SA0 | Output | B31 | GND | Power |
| A32 | GND | Power | B32 | GND | Power |
| | | | | | |
| C0 | GND | Power | D0 | GND | Power |
| C1 | /SBHE | Output | D1 | /MEMCS16 | Input |
| C2 | LA23 | Output | D2 | /IOCS16 | Input |
| C3 | LA22 | Output | D3 | IRQ10 | Input |
| C4 | LA21 | Output | D4 | IRQ11 | Input |
| C5 | LA20 | Output | D5 | IRQ12 | Input |
| C6 | LA19 | Output | D6 | IRQ13 | Input |
| C7 | LA18 | Output | D7 | IRQ14 | Input |
| C8 | LA17 | Output | D8 | /DACK0 | Output |
| C9 | /MEMR | Output | D9 | DRQ0 | Input |
| C10 | /MEMW | Output | D10 | /DACK5 | Output |
| C11 | SD8 | Input / Output | D11 | DRQ5 | Input |
| C12 | SD9 | Input / Output | D12 | /DACK6 | Output |
| C13 | SD10 | Input / Output | D13 | DRQ6 | Input |
| C14 | SD11 | Input / Output | D14 | /DACK7 | Output |
| C15 | SD12 | Input / Output | D15 | DRQ7 | Input |
| C16 | SD13 | Input / Output | D16 | +5V | Power |
| C17 | SD14 | Input / Output | D17 | /MASTER | Input |
| C18 | SD15 | Input / Output | D18 | GND | Power |
| C19 | KEY | – | D19 | GND | Power |

**Note:**

Designation in these tables: "–" is not used.

The "State" column shows direction of data transfer for CPU Module, which is a master module on the bus.

3.4.3 PC/104-PCI interface

PC/104-PCI interface (XS2) makes it possible to operate with 8- or 16-bit extension modules. For PC/104 bus, 104-contact 0.10" connector (2.54 mm) is used, which is located in the top side of the module. It is possible to use it for transferring the ISA bus signals with the frequency of 8 MHz.

The CPU Module CPC310 supports up to four PCI-104 extension modules, without any additional buffering.

Location of the contacts of PCI-104 connector is shown in Figure 3-5. Purpose of the connector contacts is shown in the Table 3-2.

Fig. 3-5: Contacts of PCI-104 (XS1) connector



Table 3-2: Purpose of PCI/104-PCI (XS1) connector contacts

| Contact | Signal | Contact | Signal | Contact | Signal | Contact | Signal |
|--------------------|--------|---------|--------|---------|---------|---------|--------|
| A1 | GND | A16 | AD21 | B1 | NC | B16 | AD20 |
| A2 | V/I/O | A17 | NC | B2 | AD02 | B17 | AD23 |
| A3 | AD05 | A18 | IDSEL0 | B3 | GND | B18 | GND |
| A4 | C/BE0# | A19 | AD24 | B4 | AD07 | B19 | C/BE3# |
| A5 | GND | A20 | GND | B5 | AD09 | B20 | AD26 |
| A6 | AD11 | A21 | AD29 | B6 | V/I/O | B21 | +5V |
| A7 | AD14 | A22 | +5V | B7 | AD13 | B22 | AD30 |
| A8 | NC | A23 | REQ0# | B8 | C/BE1# | B23 | GND |
| A9 | SERR# | A24 | GND | B9 | GND | B24 | REQ2# |
| A10 | GND | A25 | GNT1# | B10 | PERR# | B25 | V/I/O |
| A11 | STOP# | A26 | +5V | B11 | NC | B26 | CLK0 |
| A12 | NC | A27 | CLK2 | B12 | TRDY# | B27 | +5V |
| A13 | FRAME# | A28 | GND | B13 | GND | B28 | INTD# |
| A14 | GND | A29 | NC | B14 | AD16 | B29 | INTA# |
| A15 | AD18 | A30 | NC | B15 | NC | B30 | REQ3# |
| C1 | +5V | C16 | GND | D1 | AD0 | D16 | AD19 |
| C2 | AD01 | C17 | AD22 | D2 | +5V | D17 | NC |
| C3 | AD04 | C18 | IDSEL1 | D3 | AD03 | D18 | IDSEL2 |
| C4 | GND | C19 | V/I/O | D4 | AD06 | D19 | IDSEL3 |
| C5 | AD08 | C20 | AD25 | D5 | GND | D20 | GND |
| C6 | AD10 | C21 | AD28 | D6 | NC | D21 | AD27 |
| C7 | GND | C22 | GND | D7 | AD12 | D22 | AD31 |
| C8 | AD15 | C23 | REQ1# | D8 | NC | D23 | V/I/O |
| C9 | NC | C24 | +5V | D9 | PAR | D24 | GNT0# |
| C10 | NC | C25 | GNT2# | D10 | PME# | D25 | GND |
| C11 | /LOCK | C26 | GND | D11 | GND | D26 | CLK1 |
| C12 | GND | C27 | CLK3 | D12 | DEVSEL# | D27 | GND |
| C13 | IRDY# | C28 | +5V | D13 | NC | D28 | RST# |
| C14 | NC | C29 | INTB# | D14 | C/BE2# | D29 | INTC# |
| C15 | AD17 | C30 | GNT3# | D15 | GND | D30 | GND |
| NC – not connected | | | | | | | |

PCI VIO (XP10) switch is located on the top side of the board (near XS1 connector, see Fig. 3-2: Location of connectors and main components on the TOP side) and is designed for selecting power supply voltage of PCI interface buffers of PC\104- Plus, PCI-104 modules.

XP10 switch contacts have the following states:

- closed 1-2 contacts – levels of PCI bus signals: +5 V;
- closed 2-3 contacts – levels of PCI bus signals: +3.3 V.

The more detailed information on XP10 switch can be found in subsection 5.1 Selection of power supply voltage buffers on PCI bus of PC/104-Plus modules.



Note

The jumper on XP10 switch should be set in 1-2 or 2-3 positions.

3.4.4 Graphics controller

Intel Atom CPU is a highly-integrated solution combining the CPU core, as well as SDRAM/DDR3 controller and graphics adapter with 3D/2D acceleration.

This enables the module to process 2D/3D graphics. Integrated graphics controller makes it possible to directly work both with a standard analog monitor, connected via VGA (XP22) on the board, and with digital TFT panels via LVDS connectors. Support of two-monitor configurations is ensured: clone/extended desktop.

3.4.5 VGA CRT interface

For connecting analog monitor to CPC310, the top side of the board is equipped with a 10-pin XP22 connector of IDC10 type, with a pitch of 2 mm.

Fig. 3-6: VGA CRT (XP22) connector

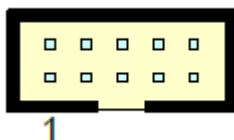

Table 3-3: Purpose of VGA (XP22) connector contacts

| Contact | Signal | Contact | Signal |
|---------|--------|---------|---------|
| 1 | RED | 6 | GND |
| 2 | GND | 7 | HSYNC |
| 3 | GREEN | 8 | VSYNC |
| 4 | GND | 9 | DDC SCL |
| 5 | BLUE | 10 | DDC SDA |

The monitor is connected using ACS00027-02 accessory from the delivery checklist, or a proprietary manufactured cable. It is recommended to use 89947-710 LF (Amphenol FCI) socket or ACS00064, ACS00064-01 accessories.

3.4.6 LVDS interface

The TOP side of the board has two 20-pin connectors of LVDS interface for digital TFT-panels for wire crimping with a contact pitch of 1.25 mm. Support of Single LVDS, 18/24 bit/pixel modes is ensured.

Fig. 3-7: LVDS (XP19, XP14) connectors

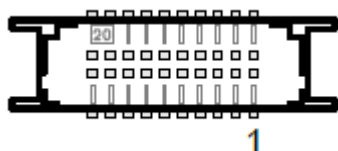

20-pin LVDS connector for digital TFT panel.

Table 3-4: Purpose of LVDS (XP19, XP14) connector contacts

| Contact | Signal | Contact | Signal |
|---------|---------|---------|---------|
| 1 | VDD | 11 | TxOUT2+ |
| 2 | - | 12 | TxOUT2- |
| 3 | TxOUT0+ | 13 | GND |
| 4 | TxOUT0- | 14 | GND |
| 5 | GND | 15 | TxOUT3+ |
| 6 | GND | 16 | TxOUT3- |
| 7 | TxOUT1+ | 17 | GND |
| 8 | TxOUT1- | 18 | GND |
| 9 | GND | 19 | TxCLK+ |
| 10 | GND | 20 | TxCLK- |

During cable manufacturing, it is recommended using connector ACS00037 accessory from additional accessories (see Table 1-3: Additional accessories), or DF13-20DS-1.25C (Hirose) socket with DF13-2630SCF (Hirose) contacts.

3.4.7 Audio interface

The module is equipped two Audio connectors for wire crimping. Interface support is implemented via Audio Codec HD Audio:

- with linear input and linear output signals (5-pin connector with a pitch of 2 mm XP17);
- with microphone input signals (2-pin connector with a pitch of 2 mm XP18);

Fig. 3-8: Audio-connector XP17

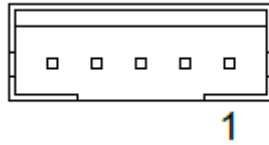
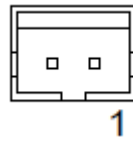

Fig. 3-9: Audio-connector XP18



The below Table 3-5 specifies the purpose of Audio connector contacts.

Table 3-5: Purpose of Audio connector contacts

| Contact | Signal | Contact | Signal |
|---------|----------------|---------|----------------|
| | XP17 connector | | XP18 connector |
| 1 | LIN_IN_L | 1 | MIC_IN |
| 2 | LIN_IN_R | | |
| 3 | GND | 2 | GND |
| 4 | LIN_OUT_R | | |
| 5 | LIN_OUT_L | | |

When manufacturing cable adapters for connection to XP17 and XP18 it is recommended to use PHR-5 (JST) / PHR-2 (JST) sockets accordingly, for crimping wires with contacts SPH-002T-P0.5S (JST), or ACS00031-01 and ACS00031-03 accessories accordingly (see Table 1-3).

3.4.8 Serial interfaces

The module is equipped with four serial ports: COM1 – COM4.

3.4.8.1 COM1 and COM2 ports

COM1 and COM2 ports are functioning in the full (9-wire) RS 232-interface mode and have basic addresses and interrupts, which are standard for PC/AT. The ports can also be used for console I/O. In this case, a number of the used COM-port for the connection of a remote console (COM1 and COM2) is selected by means of the relevant adjustment made in BIOS SETUP of the module.

Rate of data exchange for COM1 and COM2 ports is no more than – 115.2 Kb/sec. The ports are program-compatible with UART 16550 version.

COM1 and COM2 ports are routed to XP15 and XP16 connectors of IDC10 type (with a pitch of 2 mm). Purpose of XP15 and XP16 connector contacts for the connection to COM1, COM2 ports is shown in Figure 3-10.

Figure 3-10: COM1/COM2 connector (XP15 and XP16)

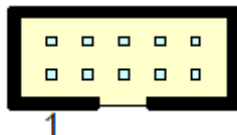

Table 3-6: Purpose of COM1, COM2 connector contacts (XP15, XP16)

| Contact | Signal | Contact | Signal |
|---------|--------|---------|--------|
| 1 | DCD | 6 | CTS |
| 2 | DSR | 7 | DTR |
| 3 | RXD | 8 | RI |
| 4 | RTS | 9 | GND |
| 5 | TXD | 10 | +5V |

When using the ports, it is recommended to apply the accessory ACS00023-04 from the delivery checklist (see Table 1-2) or accessories for independent manufacturing of ACS00064, ACS00064-01 cable (see Table 1- 3).

3.4.8.2 COM3 and COM4 ports

Serial ports: COM3 and COM4 ports are designed for operation in modes of RS 422/485 interfaces and ensure galvanic isolation (optoisolation with breakdown voltage of 500 V). The ports have basic addresses and interrupts standard for PC/AT. The data exchange rate is no more than 921 Kb/sec¹⁾. In RS485 mode, the receivers are controlled automatically. Each port can work either with a continuously switched-on receiver (ECHO mode) or with a receiver switched off at the time of data transfer.

Deactivation of the ECHO mode as well as control of connecting the matching resistors 120 Ohm (terminators) for each single port is carried out using the SETUP BIOS program.

Each port is routed to a direct 5-pin connector with a pitch of 2 mm.

Fig. 3-11: Connectors of COM3, COM4 ports (XP20, XP21)

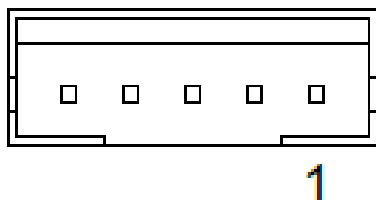

The purpose of connectors' contacts is specified in the Table 3-7.

¹⁾ For support of the rates more than 115 Kb/sec, see recommendations in the BSP of the relevant OS.

Table 3-7: Purpose of COM3 and COM4 connectors contacts (XP20, XP21)

| Contact | Signal | Contact | Signal |
|---------|--------|---------|--------|
| 1 | TX+ | 4 | RX- |
| 2 | TX- | 5 | GND |
| 3 | RX+ | - | - |

Schematic diagrams, which clarify the structure of RS 422 and RS 485 interfaces, are shown in Fig. 3-12 and Fig. 3-13.

“Point-to-point” connection of two devices using RS 422 interfaces is shown in Fig. 3-12. Terminator is installed on receiver’s side (along the RX+ and RX- lines). Combination of several devices using RS 485 interface is shown in Fig. 3-13. The terminator can only be installed in the devices connected to line ends.

Fig. 3-12 Point-to-point connection of two devices using RS 422 interface

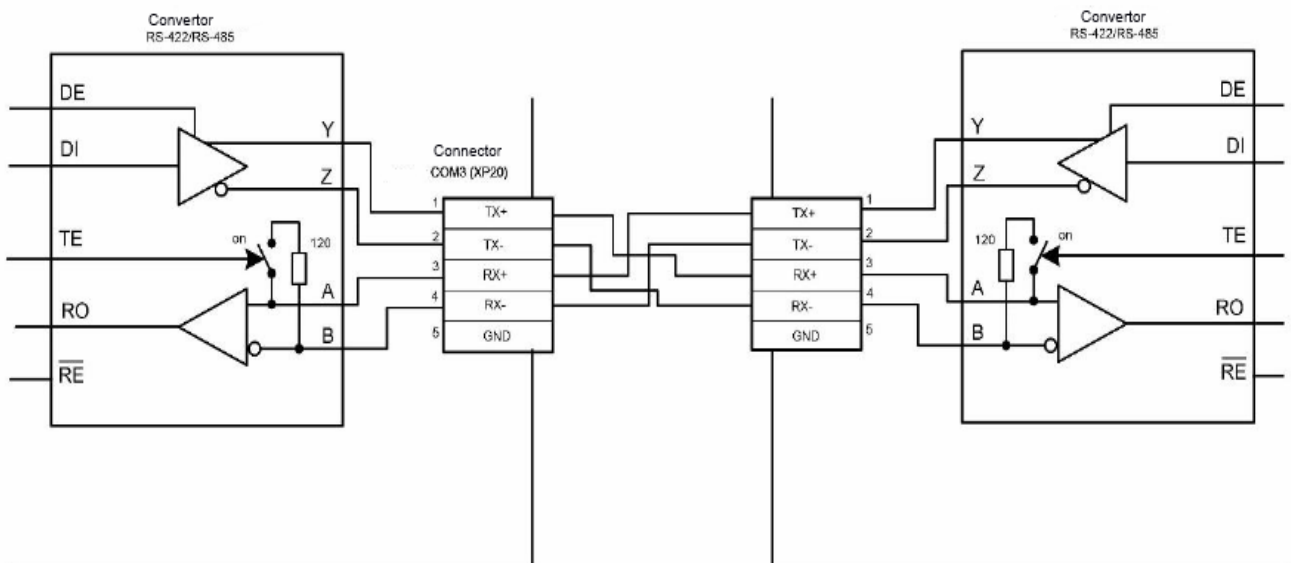
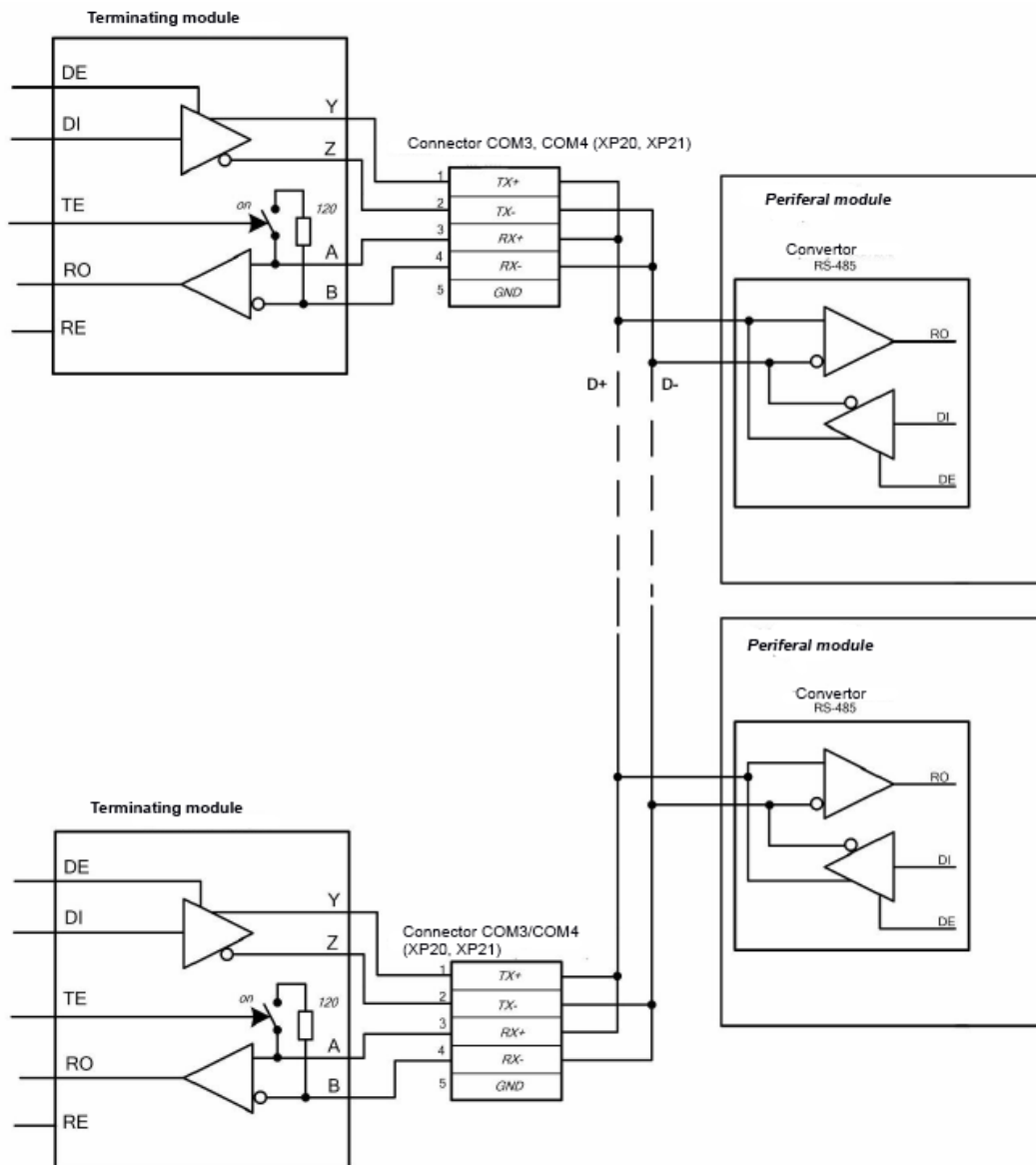

Fig. 3-13: Combining several devices via RS 485 interface



When manufacturing cable adapters for connection to XP20, XP21, it is recommended to use a socket of PHR-5 (JST) type for crimping wires with SPH-002T-P0.5S (JST) contacts, or ACS00031-01 accessory (see Table 1-3).

3.4.9 LPT parallel port

The module is equipped with a universal parallel LPT printer port (with support of EPP, ECP modes). With regard to its structure, the printer port is the 26-pin connector (XP6) of IDC26 type (with a pitch of 2 mm).

Fig. 3-14: LPT connector (XP6)

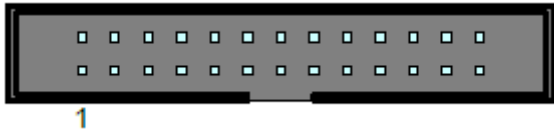

Purpose of XP6 contacts for printer connection is specified in the Table 3-8.

Table 3-8: Purpose of LPT connector contacts (XP6)

| Contact | Signal | Contact | Signal |
|---------|--------|---------|--------|
| 1 | /STB | 14 | GND |
| 2 | /AFD | 15 | PD6 |
| 3 | PD0 | 16 | GND |
| 4 | /ERR | 17 | PD7 |
| 5 | PD1 | 18 | GND |
| 6 | /INIT | 19 | /ACK |
| 7 | PD2 | 20 | GND |
| 8 | /SLIN | 21 | BUSY |
| 9 | PD3 | 22 | GND |
| 10 | GND | 23 | PE |
| 11 | PD4 | 24 | GND |
| 12 | GND | 25 | SLCT |
| 13 | PD5 | 26 | +5V |

When manufacturing the cable it is recommended to use the socket to the flat cable of 2040-3262 (Leotronics) type, or ACS00040-03 accessory (see Table 1-3).

3.4.10 USB interfaces

The module has 4x USB 2.0 channels. Interfaces are routed to the two IDC10 connectors with a contact pitch of 2mm (XP2, XP1). All the channels support OS booting from USB drive.

Fig. 3-15: USB1,2, USB3,4 connectors (XP2 and XP1)

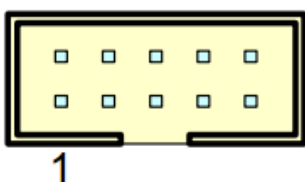

The Table 3-9 contains purposes of USB connector contacts.

Table 3-9: Purposes of contacts of USB1,2, USB3,4 connectors (XP2, XP1)

| Contact | Signal | Contact | Signal |
|---------|------------|---------|------------|
| 1 | USB1_+5V | 6 | USB2_DAT_P |
| 2 | USB2_+5V | 7 | USB1_GND |
| 3 | USB1_DAT_N | 8 | USB2_GND |
| 4 | USB2_DAT_N | 9 | - |
| 5 | USB1_DAT_P | 10 | - |

For independent cable manufacturing it is recommended to use the ACS00064, ACS00064-01 accessories (see Table 1- 3).

3.4.11 Gigabit Ethernet interface

The module has two ports 10Base-T/100Base-TX/1000Base-T Ethernet, based on Intel® Ethernet Controllers i210. Architecture of the controllers is optimized for reaching high performance at minimum power consumption. The controllers are connected to the system using high performance PCI-E bus. Intel® i210 architecture includes independent send/receive queues for limiting traffic over PCI E bus, as well as PCI-E interface, which maximizes the use of packages for efficient bus load.

The interfaces are combined in a single connector of IDC20 type, with a pitch of 2 mm (XP3).

Fig. 3-16: Gigabit Ethernet connector (XP3)

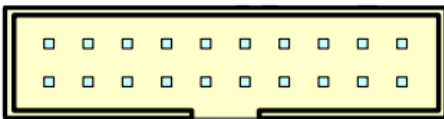

1

Interfaces ensure automatic determination of exchange rate and switching among the data transfer modes 10Base-T, 100Base-TX and 1000Base-T. Using the BIOS adjustment program or user program, each of the two Ethernet channels can be switched off independently, in order to release system resources.

Table 3-10: Purpose of contacts of Gigabit Ethernet connector (XP3)

| Contact | Signal | | Contact | Signal | |
|---------|-------------|-------------|---------|-------------|-------------|
| | 1Gb | 10/100Mb | | 1Gb | 10/100Mb |
| 1 | LAN1_BI_DA+ | LAN1_TX_D1+ | 11 | LAN2_BI_DA+ | LAN2_TX_D1+ |
| 2 | LAN1_BI_DA- | LAN1_TX_D1- | 12 | LAN2_BI_DA- | LAN2_TX_D1- |
| 3 | LAN1_BI_DB+ | LAN1_RX_D2+ | 13 | LAN2_BI_DB+ | LAN2_RX_D2+ |
| 4 | LAN1_BI_DC+ | - | 14 | LAN2_BI_DC+ | - |
| 5 | LAN1_BI_DC- | - | 15 | LAN2_BI_DC- | - |
| 6 | LAN1_BI_DB- | LAN1_RX_D2- | 16 | LAN2_BI_DB- | LAN2_RX_D2- |
| 7 | LAN1_BI_DD+ | - | 17 | LAN2_BI_DD+ | - |
| 8 | LAN1_BI_DD- | - | 18 | LAN2_BI_DD- | - |
| 9 | GND | GND | 19 | GND | GND |
| 10 | GND | GND | 20 | GND | GND |

3.4.12 CFast connector

The flash memory card is a compact removable device designed for storing information. For using the memory cards as disc drives, the lower part of CPC310 is equipped with a CFast connector (XS4):

Fig. 3-17: CFast XS4 connector

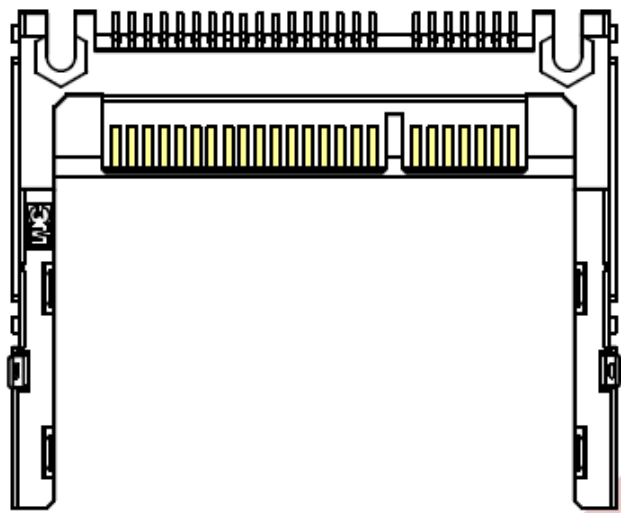

Attention!

When using the module in harsh environments, additional measures for fixing CFast device in the connector are required!

Purpose of CFast connector’s contacts is specified in the Table 3-11.

Table 3-11: Purpose of CFast connector’s contacts (XS4)

| Contact number | Signal | Contact number | Signal |
|----------------|--------|----------------|--------|
| P1 | CDI | P13 | +3.3 V |
| P2 | GND | P14 | +3.3 V |
| P3 | NC | P15 | GND |
| P4 | NC | P16 | GND |
| P5 | NC | P17 | CDO |
| P6 | NC | S1 | GND |
| P7 | GND | S2 | B_P |
| P8 | LED | S3 | B_N |
| P9 | LED | S4 | GND |
| P10 | IO | S5 | A_N |
| P11 | IO | S6 | A_P |
| P12 | IO | S7 | GND |

3.4.13 PS/2 keyboard/mouse interface

Module’s PS/2 keyboard and PS/2 mouse ports are combined in a single connector and ensure possibility of connecting input devices: PS/2 keyboard and PS/2 mouse. In terms of design, PS/2 keyboard and mouse port represents 6-output single row connector with a pitch of 2 mm for wire crimping (XP2). For connection of PS/2 keyboard to the module, use of ACS00043 cable adapter (from the delivery checklist, see Table 1-2) is recommended, if PS/2 mouse connection is also required, we recommend using ACS00043 together with Y-cable (offered as an option).

When a proprietary made cable is used, we recommend either the use of PHR-6 (JST) socket for crimping the wires with contacts SPH-002T-P0.5S (JST).

Fig. 3-18: PS/2 connector (XP7)

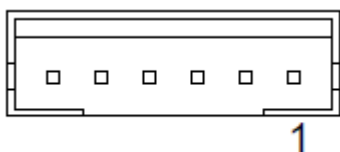

Table 3-12: Purpose of PS/2 connector contacts (XP7)

| Contact | Signal | Contact | Signal |
|---------|-----------|---------|------------|
| 1 | KBD CLK | 4 | GND |
| 2 | KBD DATA | 5 | +5V |
| 3 | MOUSE CLK | 6 | MOUSE DATA |



Note

Keyboard/mouse power supply source is protected with a fuse of 500 mA. All signal lines have electromagnetic filtration.

3.4.14 Power connector

Module’s power supply should comply with the requirements specified in Table 2-1. The power supply is carried out via both power supply connector (XP5) and via PC/104 bus connector. Maximum consumption current value is 2A¹⁾, exclusively of the connected external devices.

Before operation, please read carefully subsection 2.2 Power supply.

For connecting power supply via XP5, a power supply socket with ACS00057 contacts (included into the delivery checklist, Table 1-2) is used.

1) For CPC310-01 module

Fig. 3-19: XP5 power supply connector

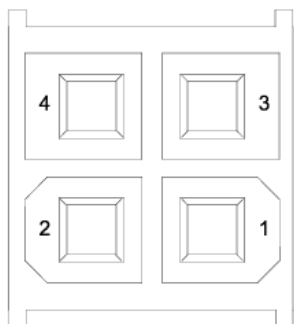

Table 3-13: Purpose of XP5 power connector’s contacts

| Contact | Signal |
|---------|--------|
| 1 | GND |
| 2 | GND |
| 3 | +5V |
| 4 | +5V |

3.4.15 Digital I/O port

The digital I/O port has 8 separately programmed I/O lines. In the output mode, each line can be programmed either to the “Push-pull” or “Open Drain” mode. Digital I/O port is routed to 12-contact single-row XP9 connector (with a pitch of 2 mm) in the upper part of the board.

Fig. 3-20: Connector of XP9 digital I/O port



The first contact of XP9 connector is specified in Fig. 3-2: Purpose of connector contacts of digital I/O port is specified in the table below.

Table 3-14: Purpose of contacts of XP9 digital I/O port connector

| Contact | Signal | Contact | Signal |
|---------|--------|---------|--------|
| 1 | IO_0 | 7 | IO_6 |
| 2 | IO_1 | 8 | IO_7 |
| 3 | IO_2 | 9 | +3.3V |
| 4 | IO_3 | 10 | +3.3V |
| 5 | IO_4 | 11 | GND |
| 6 | IO_5 | 12 | GND |

When manufacturing the cable, it is recommended to use the socket 2018-3121 (Leotronics) for crimping wires with contacts 2023-2000 (Leotronics).

3.4.16 Optoisolated external reset input

Module’s optoisolated digital input is routed to a separate connector, designed for the connection of remote (external) RESET devices and ensures galvanic isolation (optoisolation with breakdown voltage of 500 V) when connecting relevant devices to the module. In terms of its design, the optoisolated digital input represents Isolated Reset (XP23) two-pin connector with a pitch of 2 mm.

Fig. 3-21: Optoisolated external reset input XP23

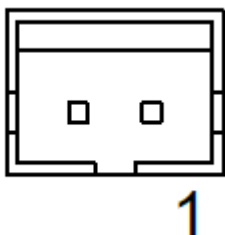

A fragment of a schematic diagram for implementation of module’s digital input optical isolation is shown in the Figure 3-22 below:

Fig. 3-22: Diagram for implementation of module’s digital input optical isolation

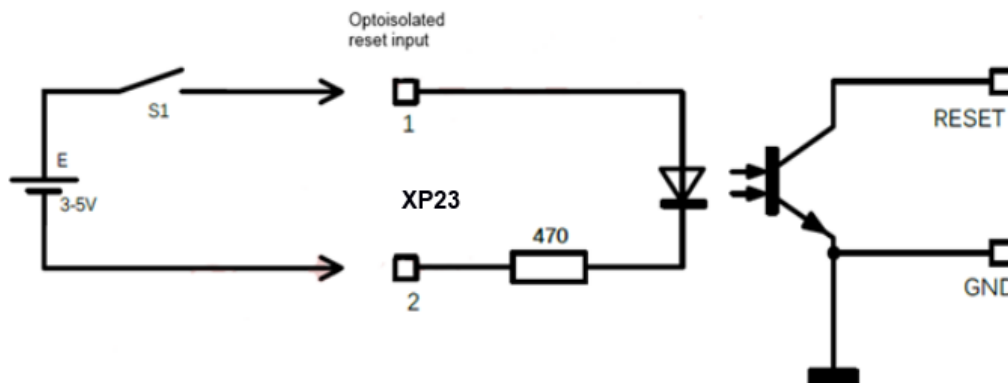

When manufacturing the cable, it is recommended to use PHR-2 socket (JST) for crimping the wire with SPH-002T-P0.5S (JST) contacts, or ACS00031-03 accessory (see Table 1-3).

3.4.17 System reset connector

CMOS Reset (XP12) two-pin connector is designed for button connection, not fixing it in a pressed condition. Pressing the button leads to system reset of the module and restart of the system.

Fig. 3-23: Reset XP12 connector

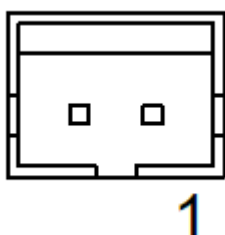

When manufacturing the cable, it is recommended to use the socket of PHR-2 (JST) type for crimping the wire with contacts SPH-002T-P0.5S (JST) or accessory ACS00031-03 (see Table 1- 3).

3.4.18 Connector for external RTC battery (Ext Batt)

Two-pin connector “Ext. Batt” (XP13) is designed for the connection of external lithium battery (+3V) to the module for the purpose to store in CMOS memory the data of real-time clock (RTC) with the disconnected external power supply of the module.

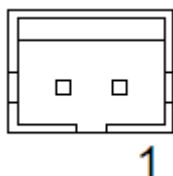

Fig. 3- 24: Connector Ext. Batt XP13

The lithium battery with a rated value of 3 V (it is recommended to use batteries of CR2032 type) is used as power supply. When manufacturing the cable it should be considered that output “1” is connected to the positive contact of the battery, output “2” – to the negative contact. It is recommended to use the socket of PHR-2 (JST) type for crimping the wires with contacts SPH-002T-P0.5S (JST) or accessory ACS00031-03 (see Table 1- 3).

3.4.19 Connector for External LEDs

XP8 connector is used for connection of external LEDs. This is a 9-pin single-row connector (with a pitch of 2 mm) in the top part of the board.

The XP8 connector makes it possible to connect the following LEDs: activity of disc drives, indication of connection and activity of LAN1 and LAN1 ports, user LED1, LED2, watchdog actuation indicator, power-on indicator.

Each LED output represents an “open collector” type output with current-limiting resistor of 300 Ohm. Therefore, LED connection is only required. LED connection diagram is shown in the Figure 3-25.

Fig. 3-25: Reset XP8 connector

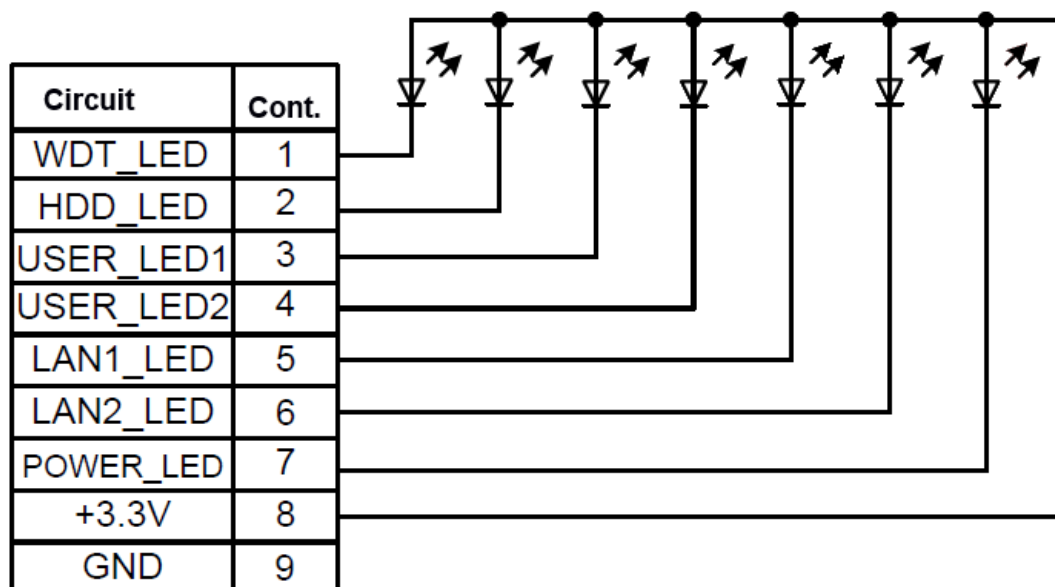

Fig. 3-26: XP8 connector for external LEDs



The first XP8 connector’s contact is specified in the Fig. 3-2. Purpose of XP8 connector contacts is shown in the Table 3-15.

Table 3-15: Purpose of connector contacts for connection of external LEDs XP8

| Contact | Circuit | Description |
|---------|-----------|-----------------------------------------------------------------------------|
| 1 | WDT_LED | Connection of watchdog timer indication LED |
| 2 | HDD_LED | Connection of drives activity LED (SATA, Onboard NAND Flash, Compact Flash) |
| 3 | USER1_LED | Connection of user LED1 |
| 4 | USER2_LED | Connection of user LED2 |
| 5 | LAN1_LED | Connection of Ethernet1 network activity LED |
| 6 | LAN2_LED | Connection of Ethernet2 network activity LED |
| 7 | POWER_LED | Connection of LED indicating CPU module’s secondary power supply sources |
| 8 | +3.3V | Connection of “anode” of all the LEDs |
| 9 | GND | “Ground” of CPU Module |

When manufacturing the cable it is recommended to use the socket 2018-3091 (Leotronics) for crimping the wires with contacts 2023-2000 (Leotronics).

3.5 LEDs

CPC310 is equipped with 7 LED indicators (see Fig 3-2). Their functional purpose is specified in the Table 3-16. All the LEDs, located on the module, duplicate the outputs to external user LEDs on XP8 connector.

Table 3-16: Purpose of LEDs

| Name | Purpose | Functions |
|---------------------|-----------------------------------------|---------------------------------------------------------------------------------------------------------------|
| HL1 (green, orange) | Power supply LED | Green – power supply is ON Orange – module is in sleep mode |
| HL2 (yellow) | Actuation LED of one of watchdog timers | Watchdog timer actuation |
| HL3 (red) | LED of SATA drives activity | |
| HL4 (green) | LED of LAN1 network controller activity | Continuous glowing – connection is established Intermittent glowing – data exchange |
| HL5 (green) | LED of LAN1 network controller activity | Continuous glowing – connection is established Intermittent glowing – data exchange |
| HL6 (yellow) | User LEDs | During BIOS initialization (prior to the assigning the OS control) yellow LED is flashing with 1 sec. period. |
| HL7 (green) | | |

3.6 Watchdog timers

In CPC310 there are two watchdog timers, one (WDT1) is integrated into supervisor’s microchip and has a fixed actuation interval (1.6 sec), the other one is integrated into SIO microchip and has a programmable actuation interval (from 1 sec to 255 min).

3.7 Module address space

3.7.1 Allocation of memory address space

Information on the allocation of module's memory address space is given in the Table 3- 17:

Table 3- 17: Allocation of memory address space

| Range of addresses | Size | Description |
|--------------------|--------|-------------------|
| 00000h – 9FFFFh | 640 KB | RAM |
| A0000h – BFFFFh | 128 KB | Video memory |
| C0000h – C7FFFh | 32 KB | BIOS video memory |
| C8000h – CBFFFh | 16 KB | BIOS video memory |
| CC000h - CFFFFh | 16 KB | Reserved |
| D0000h – D3FFFh | 16 KB | Reserved |
| D4000h – D7FFFh | 16 KB | Reserved |
| D8000h – DBFFFh | 16KB | Reserved |
| DC000h - DFFFFh | 16 KB | Reserved |
| E0000h – EFFFFh | 65 KB | BIOS POST |
| F0000h – FFFFFh | 65 KB | ROM BIOS |

3.7.2 Allocation of address space of I/O module

Information on the allocation of I/O module's address space is given in the Table 3- 18:

Table 3- 18: Allocation of I/O address space

| Range of addresses | Functions | Note |
|--------------------|-------------------------------------------|------|
| 0000h – 001Fh | DMA Master | |
| 0020h – 0021h | PIC MASTER | |
| 0022h – 003Fh | Reserved | |
| 0040h – 005Fh | TIMER | |
| 0060h – 006Fh | POST, Keyboard, Speaker, Shadow registers | |
| 0070h – 007Fh | CMOS, NMI Mask control registers | |
| 0081h – 008Fh | DMA page registers | |
| 0090h – 009Fh | Reserved | |
| 00A0h – 00BFh | PIC SLAVE | |
| 00C0h – 00DFh | DMA slave | |
| 00F0h – 00FEh | NUMERIC COPROCESSOR | |
| 0100h – 01EFh | Reserved | |
| 01F0h – 01F7h | PRIMARY IDE | |
| 01F8h – 02EFh | Reserved | |
| 02E8h – 02EFh | COM4 | |
| 02F0h – 02F7h | Reserved | |
| 02F8h – 02FFh | COM2 | |
| 0300h – 037Fh | Reserved | |
| 03B0h – 03DFh | VIDEO | |
| 03E0h – 03E7h | Reserved | |
| 03E8h – 03EFh | COM3 | |
| 03F0h – 03F7h | Reserved | |

| Range of addresses | Functions | Note |
|--------------------|----------------------------|----------------------------|
| 03F8h – 03FFh | COM1 | |
| 0400h – 04FFh | Reserved | |
| 0500h – 057Fh | Super IO Runtime registers | |
| 0580h – 0FFFh | Reserved | |
| 1000h – FFFFh | PC/104 Bus (ISA) | Access to external ISA bus |

3.7.3 Allocation of interrupt lines

Interrupt requests by default are generated by the devices being part of the module. The interrupt sources are specified in the Table 3- 19.

Alternative devices that form interrupt requests can be extension modules StackPC, StackPC-PCI, PCI-104, PCIe/104, PCI/104-Express.

Table 3- 19: Allocation of interrupt lines

| Interrupt | Main purpose (by default) | Alternative source |
|-----------|------------------------------------------------------------|-------------------------------------------------------------|
| IRQ0 | System timer | -- |
| IRQ1 | Keyboard | -- |
| IRQ2 | Interrupt 8259 | -- |
| IRQ3 | COM2 | IRQ3 line of the extension module, connected to PC\104 bus |
| IRQ4 | COM1 | IRQ4 line of the extension module, connected to PC\104 bus |
| IRQ5 | LPT | IRQ5 line of the extension module, connected to PC\104 bus |
| IRQ6 | COM3 | IRQ6 line of the extension module, connected to PC\104 bus |
| IRQ7 | IRQ7 line of the extension module, connected to PC\104 bus | -- |
| IRQ8 | RTC (Real-Time-Clock) | -- |
| IRQ9 | ACPI | -- |
| IRQ10 | COM4 | IRQ10 line of the extension module, connected to PC\104 bus |
| IRQ11 | USB/HD Audio/SATA/SMBus/PCI/PCIe | -- |
| IRQ12 | Mouse | -- |
| IRQ13 | Reserved for math coprocessor | -- |
| IRQ14 | SATA | -- |
| IRQ15 | -- | -- |

4 Installation of CPC310

It is required to strictly follow the below rules, warnings and procedures in order to properly install the module, avoid damages to the device, system components and injuring the employees.

Procedure of installation of the drivers of all the peripherals installed to the module is specified in the descriptions supplied along with these drivers. This User Manual also has no description of the procedure of installation of operating systems. Please refer to the documents attached to the particular operating system.

5 CPC310 configuration

5.1 Selection of power supply voltage for the buffers on PCI bus for PC/104-Plus modules

Prior to installation of PC/104-Plus extension modules it is required to choose the power supply voltage of PCI bus buffers by XP10 switch (PCI VIO).



Attention!

All the actions should be performed when the module's power supply is switched off.

The XP10 switch is located in the upper part of the board, see Fig. 3-2: Location of connectors and main components on the TOP side (pay attention to the note in the end of this subsection).

Fig. 5-1: State of contacts of PCI VIO switch (XP10)



1 2 3 Closed contacts 1-2 – PCI bus signal levels: +5 V



1 2 3 Closed contacts 2-3 – PCI bus signal levels: +3.3 V



Attention!

Jumper on XP10 switch should be set in 1-2 or 2-3 positions.

5.2 Clearing CMOS factory settings

If the system fails to boot (e.g. due to misconfiguration of BIOS or invalid password), the settings parameters saved in CMOS can be cleared using CMOS Reset switch (XP11), see Fig. 3-2.

CMOS reset sequence:

1. Turn off the power supply.
2. Close the CMOS Reset (XP11) switch by a jumper included into the module's delivery checklist.
3. Turn on the power supply.
4. Turn off the power supply.
5. Release the CMOS Reset (XP11) switch.

6. Turn on the power supply.
7. Further booting will be carried out using the CMOS factory settings.
8. The factory settings will be saved in Flash-memory upon POST completion.
9. When CMOS parameters are required to be changed, start BIOS Setup.

5.3 BIOS update

The BIOS update is carried out using the Flash Programming Tool utility (is available at network file-servers of manufacturer and official distributor), which is to be launched from the EFI Shell console.

Actions for BIOS update:

1. Copy the EFI64 utility, fparts.txt and the file with the new BIOS to the root directory of the USB drive.
2. Connect USB drive to the module.
3. Select the "Save & Exit -> Launch EFI Shell from filesystem device" menu in the BIOS SETUP.
4. In command line, type:
fs1:
fpt64.efi -f <file name> (pressing "Alt+Tab" enabling to select the file)
5. Wait for the update to complete and "FPT Operation Passed" to appear on the screen.
6. Reboot the system.



Attention!

In case of any BIOS modification errors appear on the screen, it is required to restart the EFI64 utility on the PC (leaving the module's power supply on)!



Attention!

It is prohibited to write the BIOS files, except for those specified for use by the manufacturer, included into the delivery checklist of the module or available at network file-servers of manufacturer and official distributor!

6 CPC310 programming

6.1 Operation with digital I/O port

The digital I/O port has 8 separately programmable I/O lines. In the output mode, each line can be programmed to either "Push-pull" or "Open Drain" mode. Description and programming examples are specified in the description of the BSPs of the corresponding operating systems that support this port.

6.2 Operation with watchdog timers

The module has two watchdog timers. one (WDT1) is integrated into the supervisor microcircuit and has a fixed actuation interval (1.6 s), the other one (WDT2) is integrated into the Super IO SMSC3114 chip and has a programmable switching interval (from 1 s to 255 min). Description and examples of programming watchdog timers are specified in the description of BSPs of the corresponding OS that support them. To configure and manage the WDT2 watchdog timer, you can also use four registers in the module I/O space, Table 6-1 shows the purpose and addresses of these registers.

Table 6- 1: Registers for control the WDT2 watchdog timer

| Name | Address | Description |
|---------------------------------------------------------------------------|---------|--------------------------------------------------------------------------------------------------------------------------------------------------------------------------------------------------------------------------------------------------------|
| WDT2_TIMEOUT | A65h | Register for configuration of resolution capability of actuation time of the WDT2 watchdog timer. |
| | | Bits[6:2] Reserved |
| | | Bit [7] "0" – Time is counted in minutes "1" – time is counted in seconds |
| WDT2_VAL | A66h | Register for configuring the actuation time of the WDT2 watchdog timer |
| | | Bits[7:0] The relevant value is written to the register, e.g.: 01h – actuation time is 1 minute or second ¹⁾ FFh –actuation time is 255 minutes or seconds In case the 00h value is written – the watchdog timer is switched off |
| WDT2_CFG | A67h | Register for configuring the WDT2 watchdog timer |
| | | Bit [0] Reserved |
| | | Bit[1] "0" – prohibition to reset the watchdog timer due to keyboard interrupt "1" – watchdog timer can be reset due to keyboard interrupt |
| | | Bit[2] "0" - prohibition to reset the watchdog timer due to mouse interrupt "1" - watchdog timer can be reset due to mouse interrupt |
| | | Bit[3] Reserved |
| | | Bits[7:4] Reserved (should be "0") |
| WDT2_CTRL | A68h | Register for control of the WDT watchdog timer |
| | | Bit [0] During reading: "0" - watchdog timer count is carried out "1" – watchdog timer count was carried out |
| | | Bit[1] Reserved |
| | | Bit[2] When writing "1" – count of the watchdog timer is finished immediately (watchdog timer is actuated) |
| | | Bit[3] "1" – count of the watchdog timer is finished by pressing a keyboard button "0" –keyboard has cannot effect on the operation of the watchdog timer |
| 1) Time is counted in seconds if the bit [7] is set in the A65h register. | | |

7 BIOS

The module is equipped with an adapted version of the AMI® BIOS, which is the standard system for IBM PC AT-compatible computers. It supports Intel® x86 processors and CPUs compatible with them, provides low-level support for the processor, memory and I/O subsystems.

Using the BIOS Setup program (BIOS Setup), you can change the BIOS settings and control the special modes of the module operation. It allows you to change the basic settings of the system.

7.1 Entering BIOS SETUP

To enter the BIOS Setup, press the "Del" or "ESC" key on the keyboard when the system is booted during the POST (Power On Self-Test) procedure. An example of the POST procedure screen is shown in Fig. 7-1.

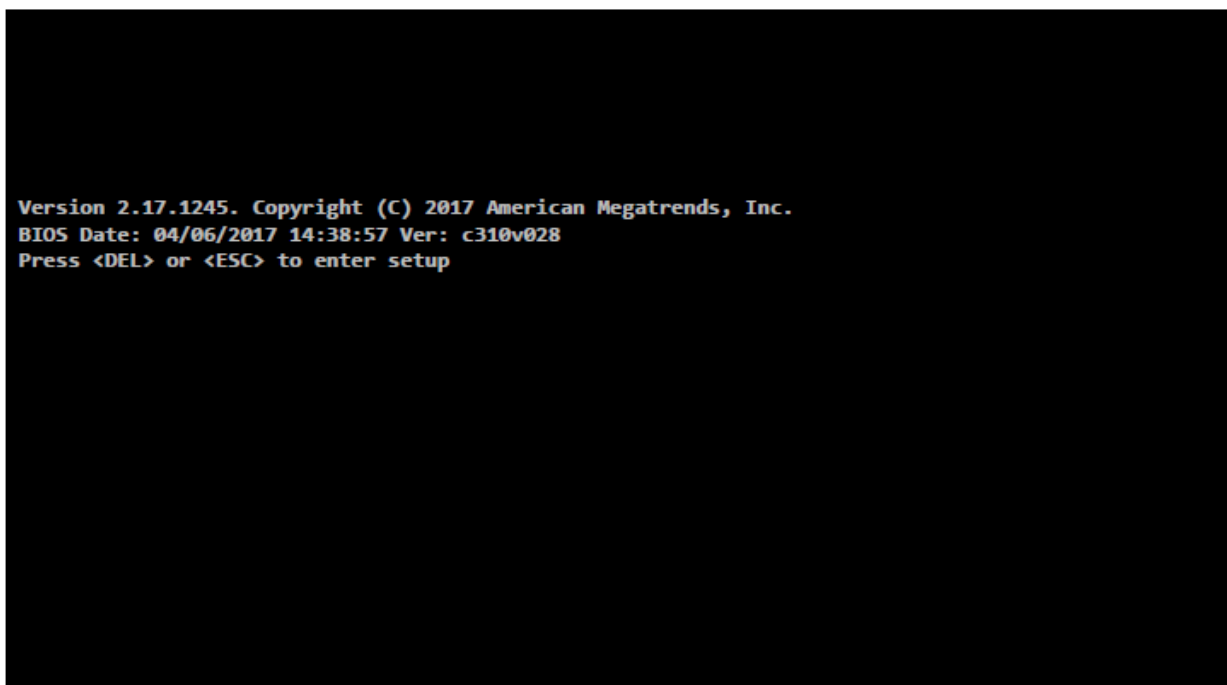

Figure 7- 1: Screen during the module booting process (POST)

After pressing the "DEL" or "ESC" key, the BIOS Setup menu appears with the active "Main" tab.

7.2 Main

This BIOS Setup tab is the head tab during entry. The "Main" menu displays information about the version and date of the BIOS release, the amount of RAM installed in the module, etc., and also enables to set the current time and date.

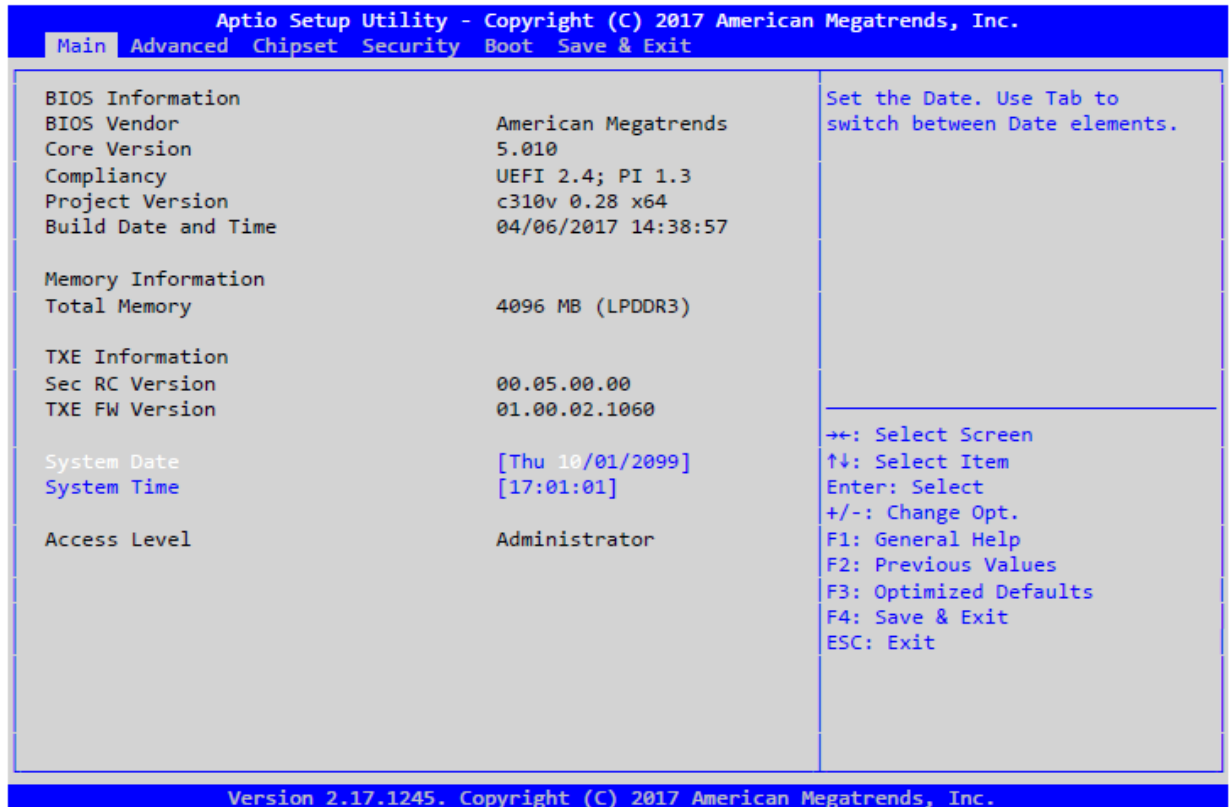

Figure 7- 2: Screen of the "Main" menu tab

To move through the menu items use the "Up" and "Down" cursor keys. To move through the tabs - the "Left" and "Right" cursor keys. To enter the setup submenu, use the "Enter" key, to exit the setup submenu use the "Escape" key. To change any values in the selected menu item, use the "+" and "-" keys of the numeric keypad.



Note!

This menu work algorithm applies to all other tabs of the BIOS Setup program.

7.3 Advanced

This tab is used for additional module settings. Figure 7-3 shows the “Advanced” tab menu.

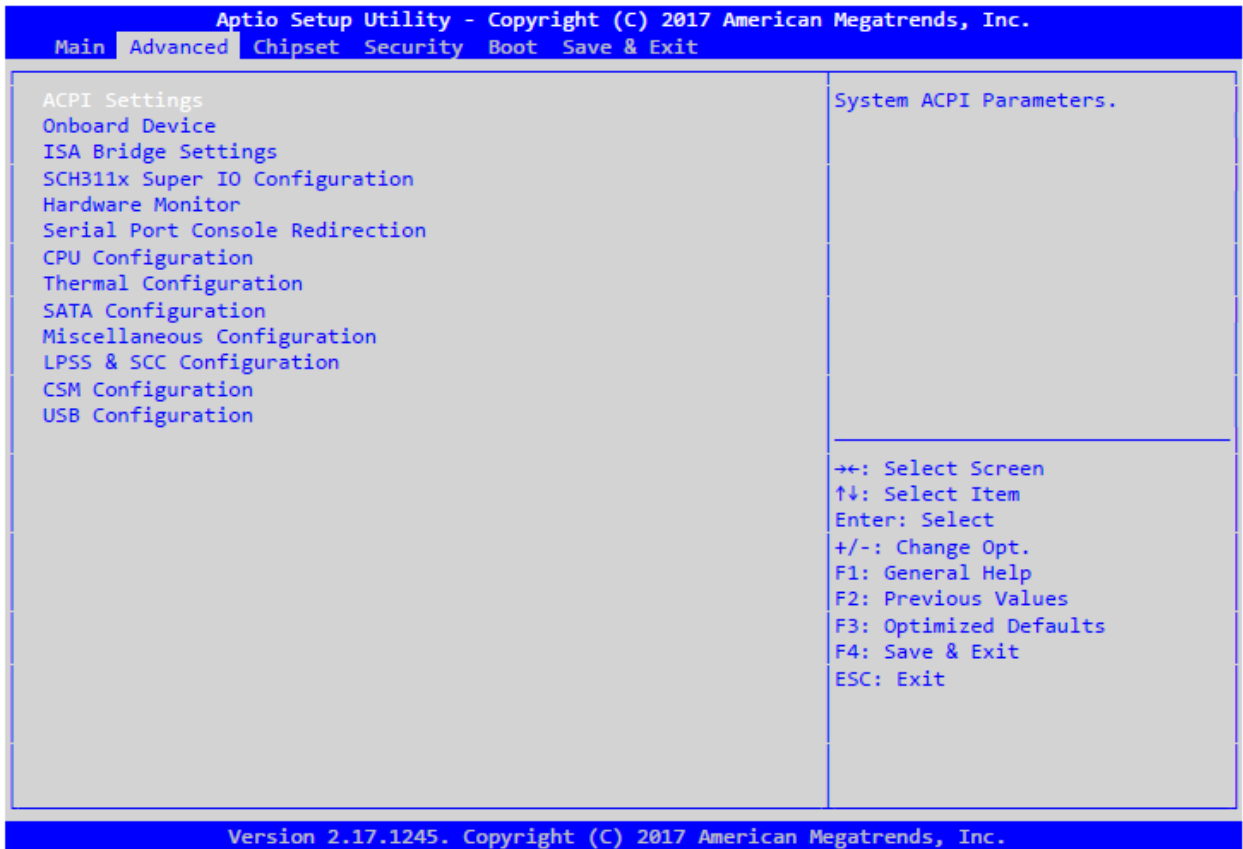

Figure 7- 3: Screen of the “Advanced” menu tab

This tab has submenus available for additional settings.

7.3.1 ACPI Settings

Submenu for setting the ACPI parameters. The submenu is shown in Figure 7- 4.

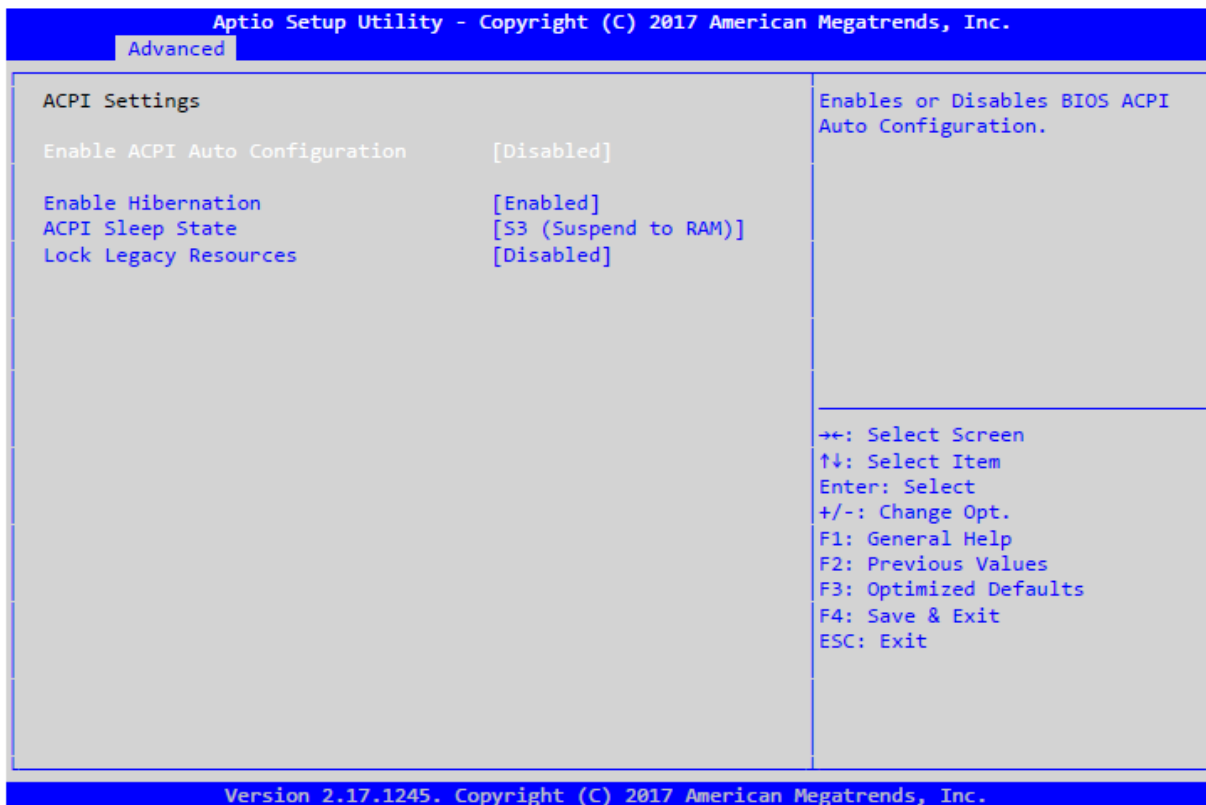

Figure 7- 4: Screen of the “ACPI Settings” submenu

Where:

Enable ACPI Auto Conf – The submenu for enabling the ACPI automatic configuration.

[Disabled] – ACPI automatic configuration is disabled.

[Enabled] – ACPI automatic configuration is enabled.

Enable Hibernation – The submenu for enabling the module to switch to hibernation mode.

[Enabled] – Switching to hibernation mode is enabled.

[Disabled] – Switching to hibernation mode is disabled.

ACPI Sleep State – Submenu for enabling the module to switch to sleep mode.

[S3 (Suspend to RAM)] – Switching to the sleep mode (S3) is enabled.

[Disabled] – Switching to the sleep mode is disabled.

Lock Legacy Resources – Submenu for fixing the system resource allocation.

[Enabled] – Fixed.

[Disabled] – Unlocked.

7.3.2 Onboard Device Configuration

Submenu for setting the parameters of additional devices integrated into the module. The submenu is shown in Figure 7- 5.

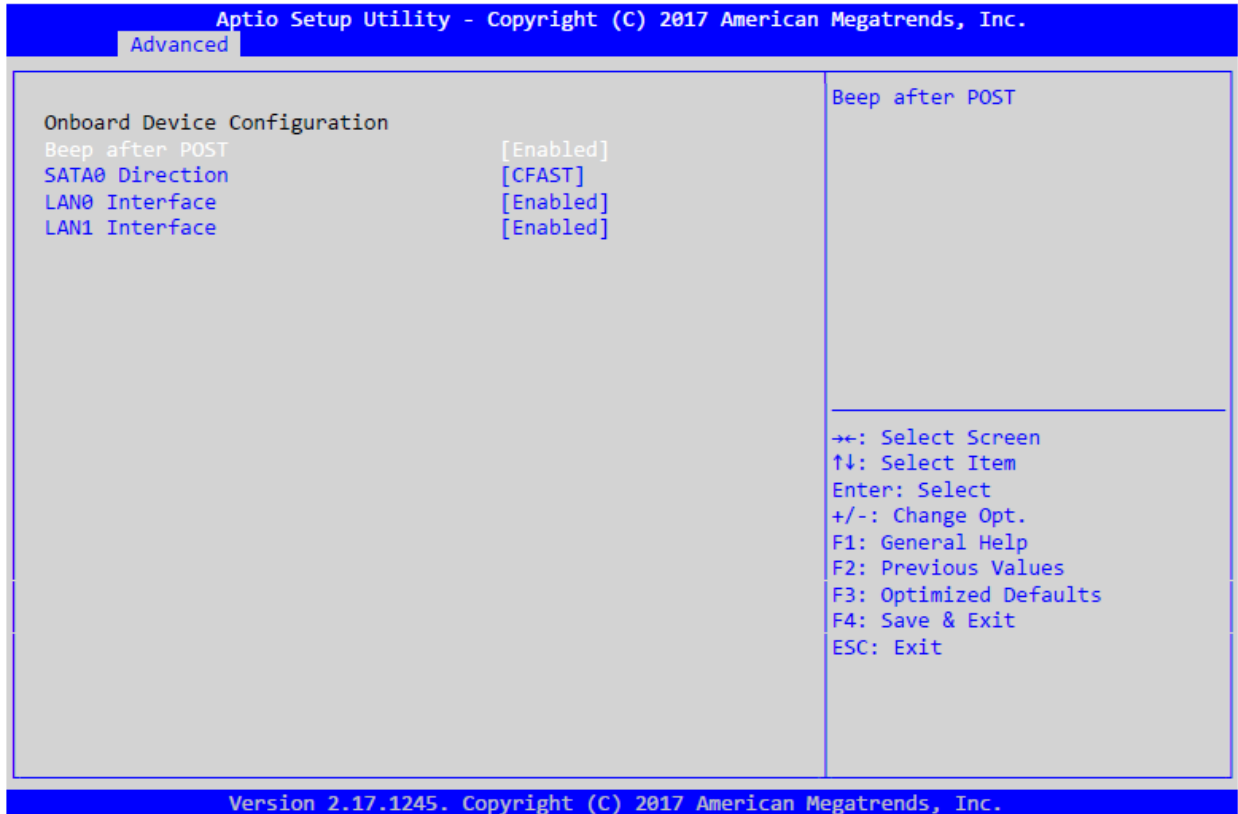

Figure 7- 5: Screen of the “Onboard Device Configuration” submenu

Where:

Beep after POST – A submenu for activating the buzzer indicating the completion of the POST and assigning control to the operating system.

[Enabled] – Buzzer is enabled.

[Disabled] – Buzzer is disabled.

SATA0 Direction – The submenu for switching the operating mode of the SATA0 channel.

[CFAST] – The SATA0 channel is connected to the XS4 (CFAST).

[SATA0] – The SATA0 channel is connected to the SATA_T0, SATA_R0 circuits of XP4 (StackPC) connector.

LAN0 Interface – The submenu for LAN0 (Ethernet) interface control.

[Enabled] – LAN0 interface is enabled.

[Disabled] – LAN0 interface is disabled.

LAN1 Interface – Submenu for LAN1 (Ethernet) interface control.

[Enabled] – LAN1 interface is enabled.

[Disabled] – LAN1 interface is disabled.

7.3.3 ISA Bridge Settings

The submenu **ISA Bridge Settings** - (PCI – ISA bridge) makes it possible to enable/disable the use of the ISA bus and, accordingly, free up the resources it occupies. The submenu is shown in Figure 7-6.

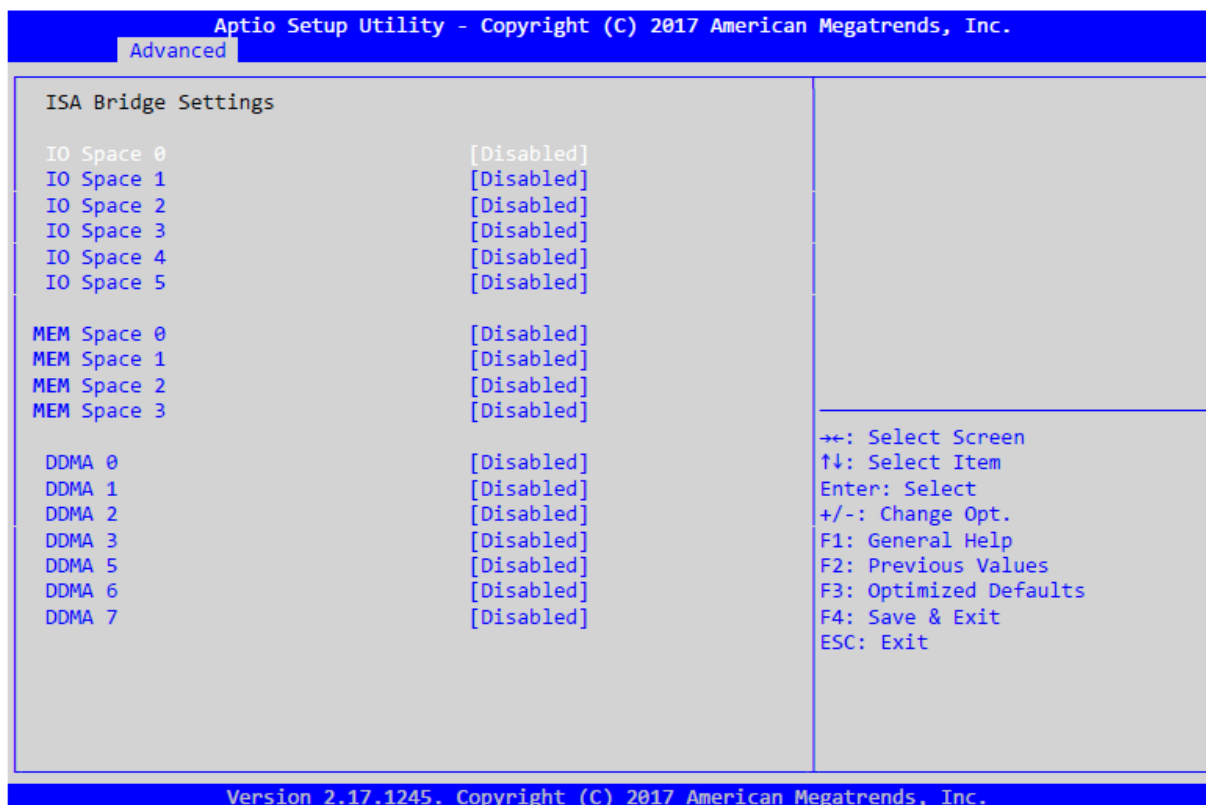

Figure 7- 6: Screen of the “ISA Bridge Settings” submenu

6 ranges of address space for I/O ports, 4 memory address ranges, and up to seven DDMA channels are available for configuration (DMA controller in the PCI-ISA IT8888 bridge chip is used).

When setting the range of I/O ports, the following options are available:

IO Space x – The submenu for setting the range of I/O port (where x is the range number).

[Disabled] – The range is disabled.

[1byte ... 128 bytes] – The range is enabled with the setting of the range size.

This setting opens additional range settings:

Base Address (Hex) - [1000...ffff] – Setting the base address of the range (within the ranges 1000h - FFFFh).

Ignore A[15:10] – This setting makes it possible for the bridge IT8888 to ignore bits A[15:10] of the address when referring to I/O ports.

Decoding Speed – Configuring the way of decoding addresses on PCI bus (**Slow** –bus lock during the 3rd cycle, **Medium** – bus lock during the 2nd cycle, **Fast**- bus lock during the 1st cycle), recommended parameter – “**Medium**”.

MEM Space x – Submenu for memory range setting (where x is the range number).

[Disabled] – Range is disabled.

[16 KB ... 2 MB] – The range is enabled with the setting the range size. This configuration opens additional range settings:

Base Address (One Hex) - [0...ffff] – Configuration of the range basic address (within the ranges FDxxx00h, where xxxx – the installed value in menu **Base Address**).

Decoding Speed – Configuring the way of decoding addresses on PCI bus (**Slow** – bus lock during the 3rd cycle, **Medium** – bus lock during the 2nd cycle, **Fast**- bus lock during the 1st cycle), recommended parameter – “**Medium**”.

DDMA x – Submenu for DMA channel configuration. (where x – number of DMA channel).

[Disabled] – the relevant DMA channel is disabled

[Enabled] – the relevant DMA channel is enabled. This configuration opens additional settings of the channel:

Base Address (Hex) - [1000...ffff] – Configuration of the Width basic address – Channel width (8bit, 16bit).

7.3.4 SCH311x Super IO Configuration

Submenu for setting the serial interface parameters UART (COM1, COM2, COM3, COM4) of the Super IO SCH311x chip. The submenu is shown in Figure 7-7.

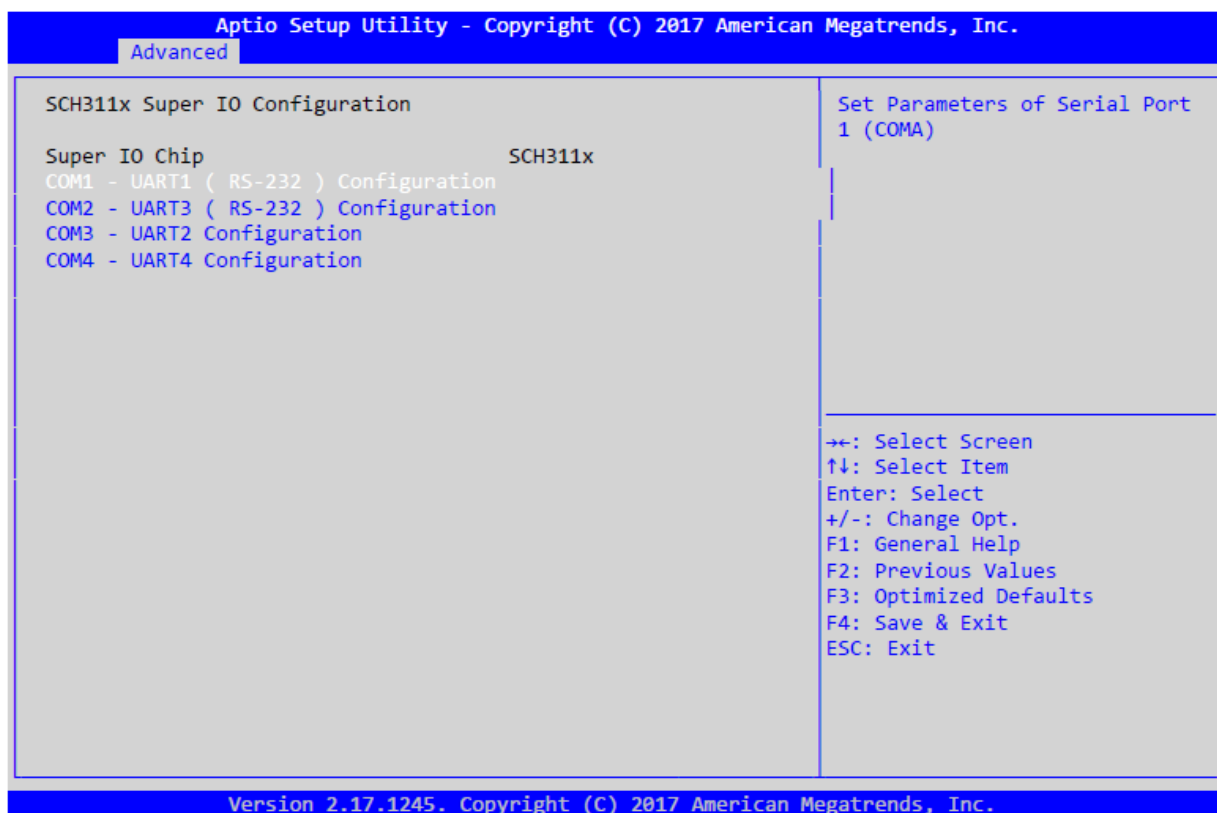

Figure 7- 7: Screen of the “SCH3114x Super IO Configuration” submenu

Where:

COM1 – UART1 (RS-232) Configuration – The submenu for setting the UART1 port (RS-232). Makes it possible to enable/disable the port, outputs information about the assigned base address, the interrupt request line.

COM2 – UART3 (RS-232) Configuration – The submenu for setting the UART3 port (RS-232). Makes it possible to enable/disable the port, output information about the assigned base address, the interrupt request line.

COM3 – UART2 Configuration – The submenu for setting the UART2 port (RS-422/485). Makes it possible to enable/disable the port, enable/disable the “terminator”,

enable/disable the "ECHO" mode, output information about the assigned base address, interrupt request line.

COM4 - UART4 Configuration - The submenu for setting the UART4 port (RS-422/485). Makes it possible to enable/disable the port, enable/disable the "terminator", enable/disable the ECHO mode, output information about the assigned base address, interrupt request line.

7.3.5 Hardware Monitor

Submenu for displaying the system state information is shown in Figure 7- 8.

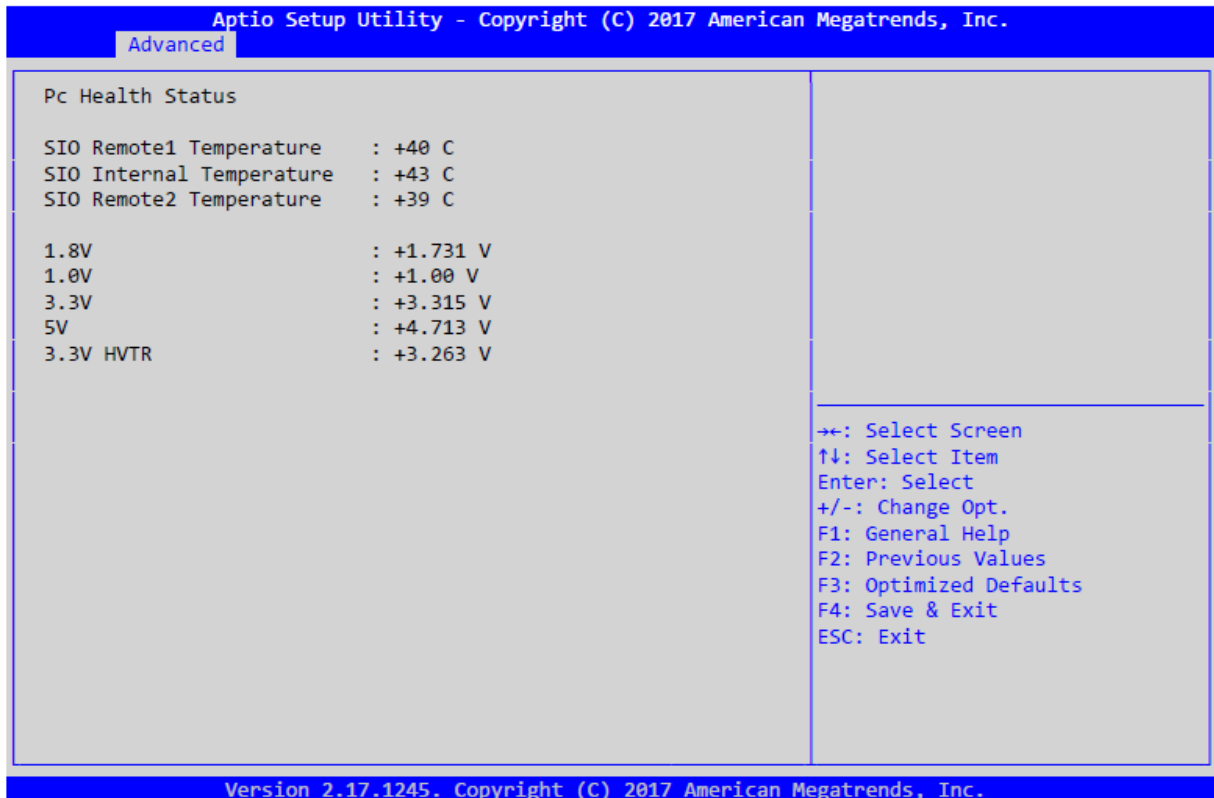

Figure 7- 8: Screen of the "Hardware Monitor" submenu

This submenu displays information about the temperatures of the printed circuit board (PCB) under the CPU (Remote 1), PCB temperatures in the RAM area (Remote 2) and PCB in the area of the Super IO SCH311x (Internal) chip.

Information on the voltage levels of important nodes is also displayed.

7.3.6 Serial Port Console Redirection

Submenu for configuration and activation of console I/O via serial ports COM1, COM2. The submenu is shown in Figure 7- 9.

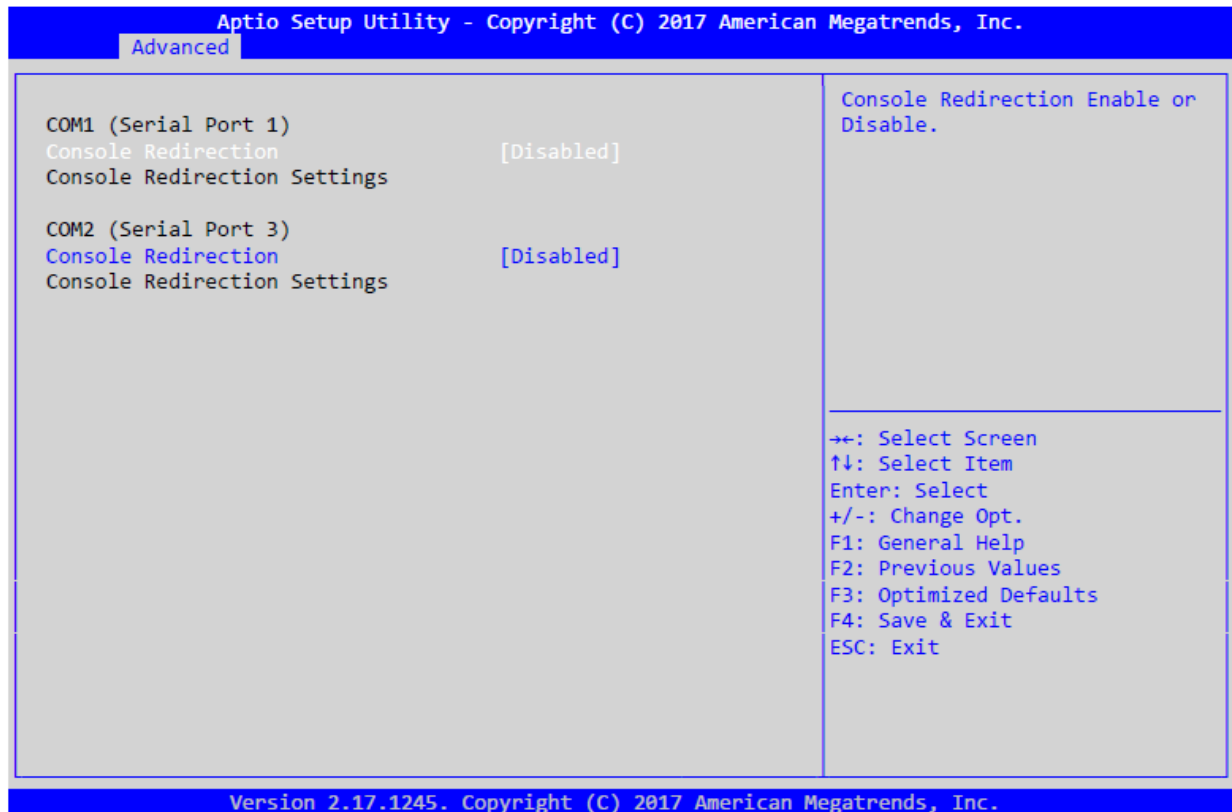

Figure 7- 9: Screen of the “Serial Port Console Redirection” submenu

Where:

COM1 (Serial Port 1) – Submenu for enabling and controlling console I/O via COM1 serial port. When enabled (Console redirection "Enabled"), the "**Console redirection Settings**" submenu becomes available, where the parameters of the console terminal for console input can be configured.

COM2 (Serial Port3) – Submenu for enabling and controlling console I/O via COM2 serial port. When enabled (Console redirection "Enabled"), the "**Console redirection Settings**" submenu becomes available, where the parameters of the console terminal for console input can be configured.

7.3.7 CPU Configuration

Submenu settings of the microprocessor. The submenu is shown in Figure 7- 10.

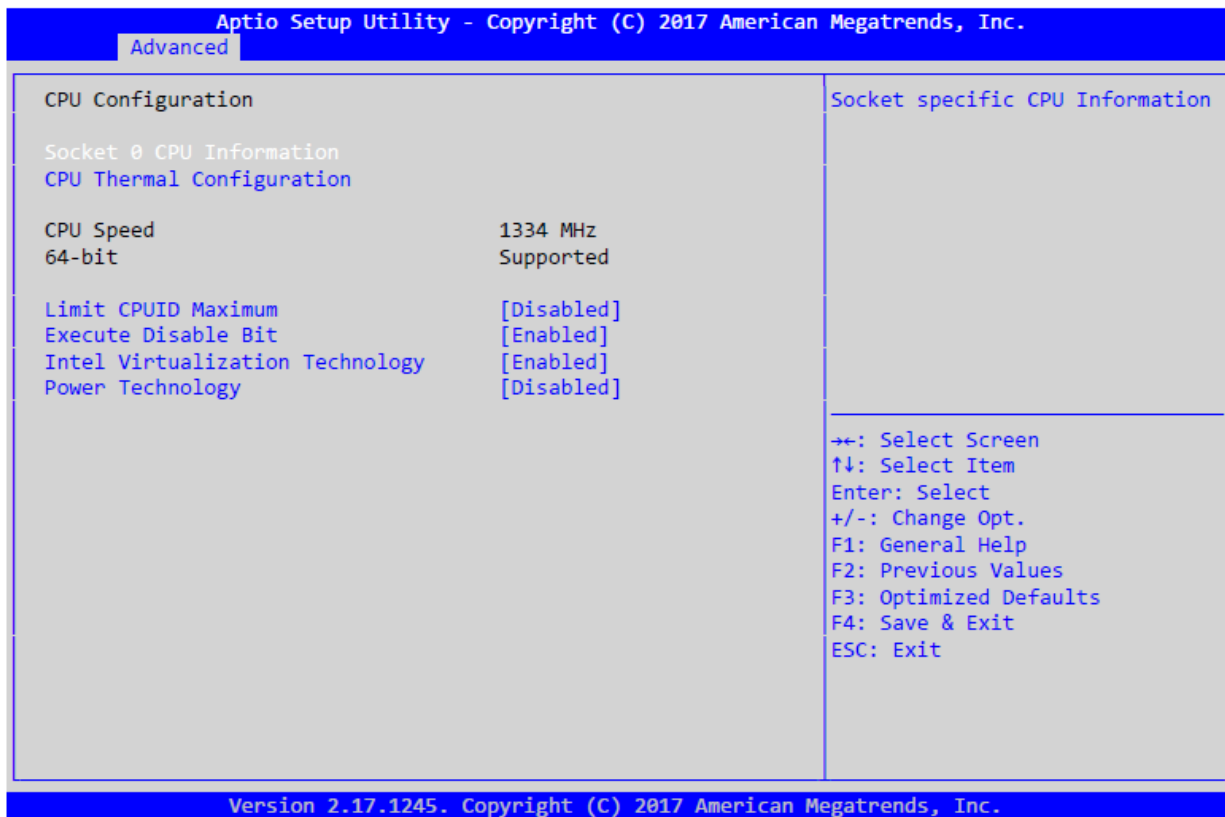

Figure 7- 10: Screen of the “Serial Port Console Redirection” submenu

Where:

Socket 0 CPU Information – The submenu for displaying information on the CPU installed in the module.

CPU Thermal Configuration – The submenu for enabling the microprocessor's digital temperature sensor.

Limit CPUID Maximum – Setting the maximum value of the microprocessor identifier (to support older operating systems):

[Enabled] – Enabled.

[Disabled] – Disabled (when using Windows XP or older versions).

Execute Disable Bit – Control of the blocking the program code execution from the data area:

[Enabled] – Blocking is enabled.

[Disabled] – Blocking is disabled.

Intel Virtualization Technology – Enabling virtualization technology (for hardware support of virtual machines):

[Enabled] – Enabled.

[Disabled] – Disabled.

Power Technology – Settings by CPU power-saving functions:

[Disabled] – Power-saving functions are disabled.

[Energy Efficient] – Maximum energy efficiency mode.

[Custom] – Custom adjustment of the energy efficiency mode.

7.3.8 SATA Configuration

Submenu for configuration of SATA interfaces. This submenu shows information on the connected SATA devices, and individual settings are available as well. The submenu is shown in Figure 7-11.

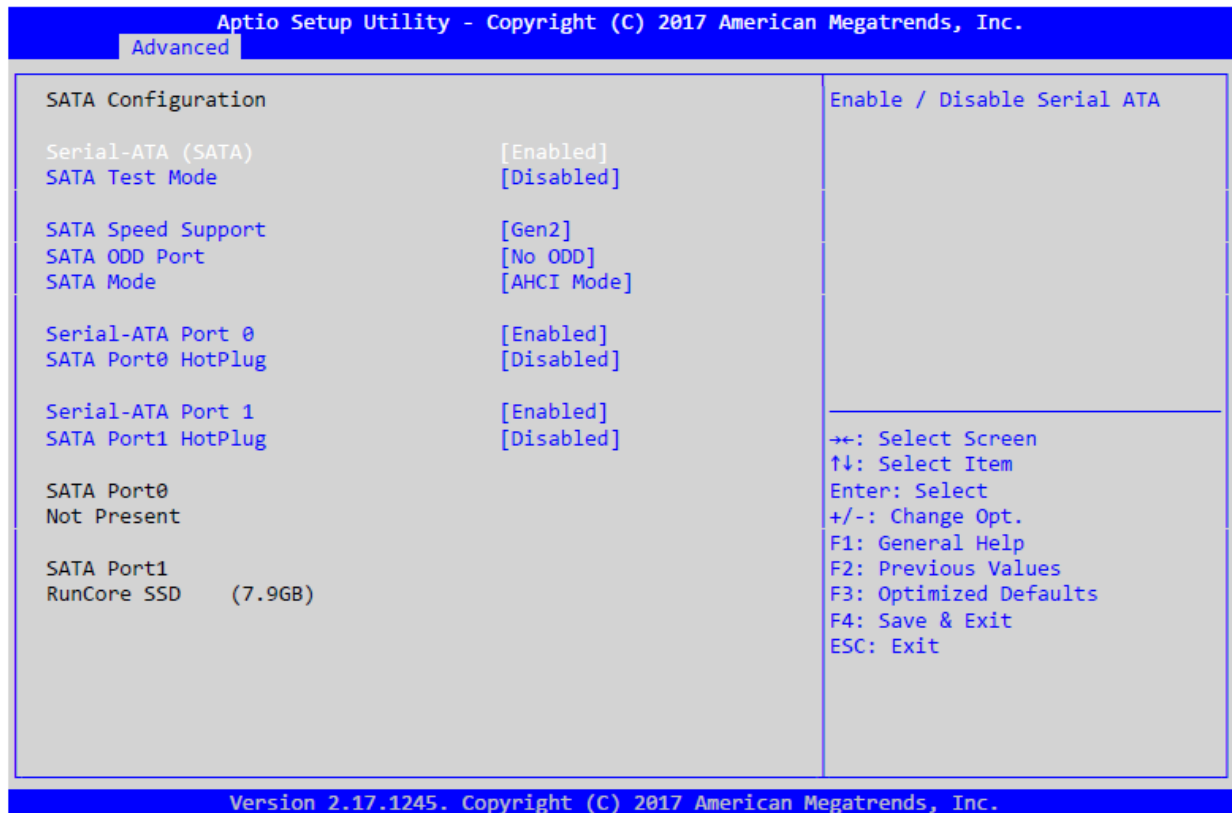

Figure 7- 11: Screen of the “SATA Configuration” submenu

Where:

Serial-ATA (SATA) – enabling/disabling SATA controller:

[Enabled] – Enabled.

[Disabled] – Disabled.

SATA Speed Support – Selection of SATA interface specification:

[GEN1] – SATA Revision 1.0 specification (rate up to 1.5 Gb/sec).

[GEN2] –SATA Revision 2.0 specification (rate up to 3.0 Gb/sec).

SATA ODD Port – Selection of the SATA port to which the disk drive on the optical carrier (CD/DVD-ROM) is connected:

[No ODD] – The disk drive is not connected.

[Port0 ODD] – The disk drive is connected to Port0.

[Port1 ODD] – The disk drive is connected to Port1.

SATA Mode – Operating mode of SATA-controller:

[AHCI Mode] – AHCI mode is enabled.

[IDE Mode] – IDE simulation mode is enabled.

For each port individual enabling/disabling of the "**Serial-ATA Port 0,1**", as well as enabling/disabling the "**SATA Port 0.1 HotPlug**" hot swap mode of the device are available.

7.3.9 Miscellaneous Configuration

Submenu of miscellaneous configuration. The submenu is shown in Figure 7- 12.

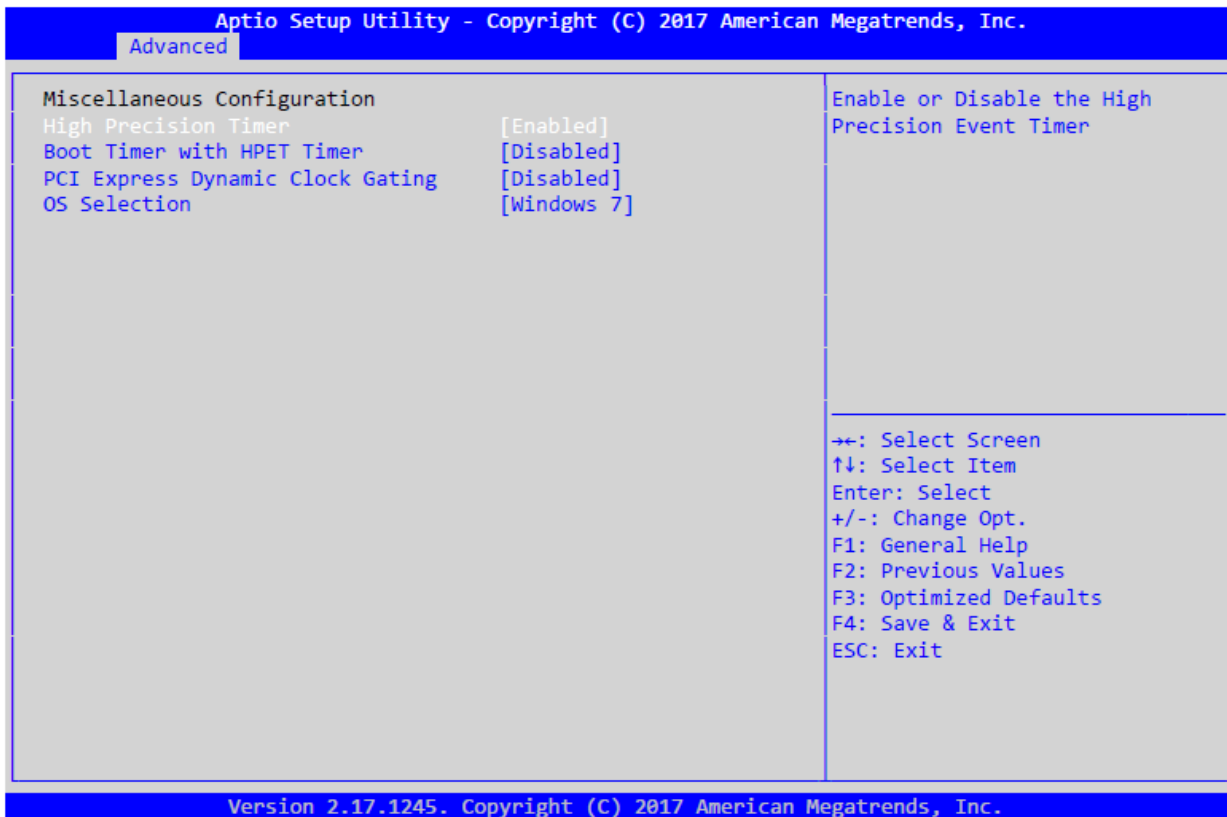

Figure 7- 12: Screen of the “Miscellaneous Configuration” submenu

Where:

High Precision Timer – Enabling/disabling the High precision Event Timer:

[Enabled] – Timer is enabled.

[Disabled] – timer is disabled.

Boot Timer with HPET Timer – Enabling/Disabling counting the start time of the High-Precision Events Timer:

[Enabled] – Enabled.

[Disabled] – Disabled.

PCI Express Dynamic Clock Gating – Enabling/disabling the clocking signal in the non-used PCI Express circuits:

[Enabled] – Enabled.

[Disabled] – Disabled.

OS Selection – Selection of OS type for booting:

[Windows 7] – Microsoft Windows 7 is selected.

[Windows 8.X] – Microsoft Windows 8 or 8.1 is selected.

[Android] – Android is selected.

7.3.10 LPSS & SCC Configuration

Submenu for configuration of the subsystem of serial interfaces and storage system (High speed UART, I2C, SPI, MicroSD). The submenu is shown in Figure 7- 13.

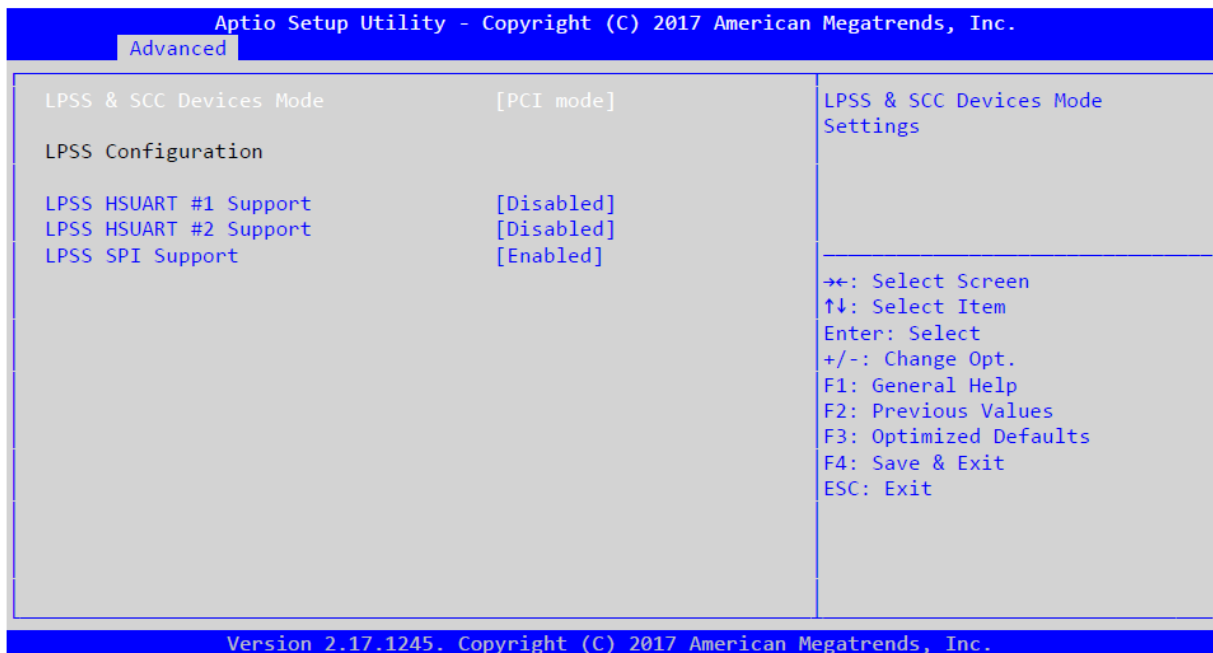

Figure 7- 13: Screen of the “LPSS & SCC Configuration” submenu

Where:

LPSS HSUART #1,2 Support – Enabling/disabling High Speed UART interfaces:

[Enabled] – Enabled.

[Disabled] – Disabled.

LPSS SPI Support – Enabling/disabling SPI interface:

[Enabled] – Enabled.

[Disabled] – Disabled.

7.3.11 CSM Configuration

The Submenu for configuration of compatibility support of the module (Compatibility Support Module).

Used to boot Legacy operating systems and interaction with the dated firmware. The submenu is shown in Figure 7-14.

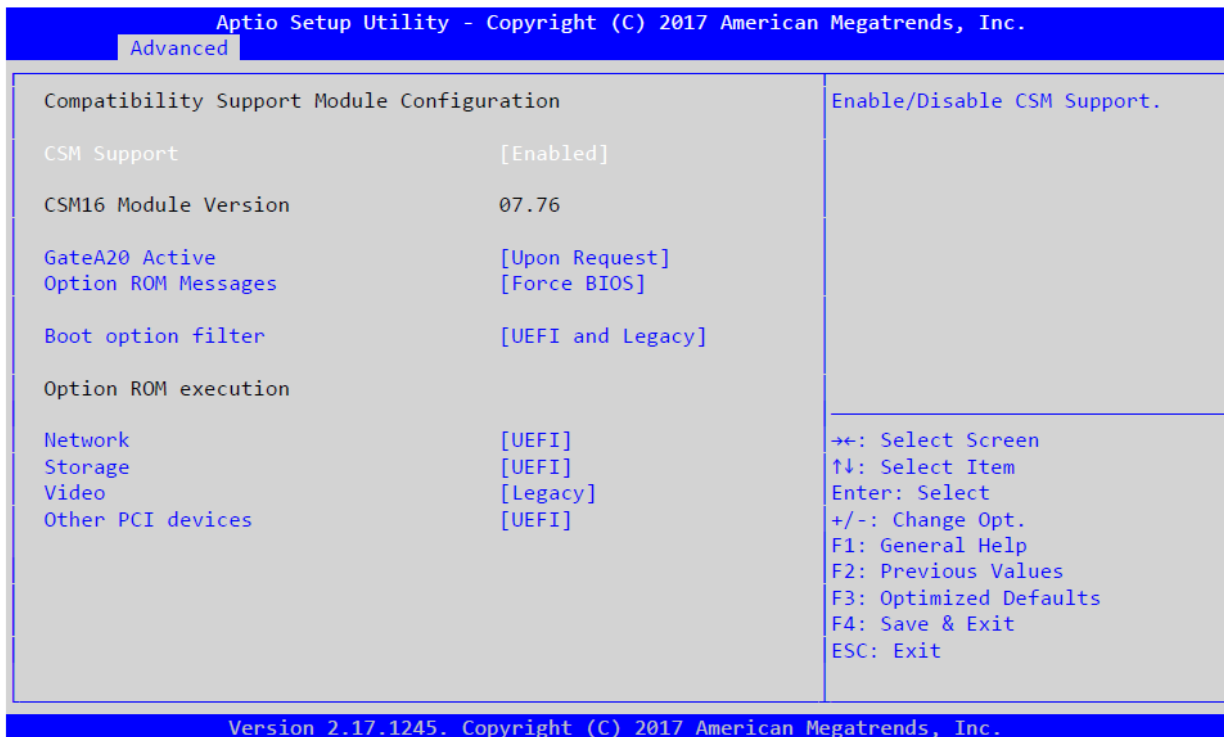

Figure 7- 14: Screen of the “CSM Configuration” submenu

Where:

CSM Support – Enabling/Disabling the Compatibility Support Module (CSM):

[Enabled] – Enabled.

[Disabled] – Disabled.

GateA20 Active – Control of Gate A20:

[Upon Request] – the gate can be disabled using the BIOS means.

[Always] – The gate is always enabled.

Option ROM Messages – Method for displaying Option ROM:

[Force BIOS] – Displaying information on Option ROM is enabled.

[Keep Current] – Displaying information on Option ROM is disabled.

Boot option filter – Boot mode filter:

[UEFI and Legacy] – Support of the both UEFI and Legacy booting.

[Legacy only] – Support of Legacy booting only.

[UEFI only] – Support of UEFI booting only.

Further, the booting settings of the Option ROM mode (**Option ROM execution**) from various devices are shown (**Network** - network controllers, **Storage** - storage controllers, **Video** - video controllers, **Other PCI devices** - other PCI devices). Configuration is available for each device:

[Do not launch] – Do not launch the Option ROM for this type of device.

[UEFI] – Launch the Option ROM for this type of device in UEFI mode.

[Legacy] – Launch the Option ROM for this type of device in Legacy mode.

7.3.12 USB Configuration

Submenu of USB configuration. The submenu is shown in Figure 7- 15.

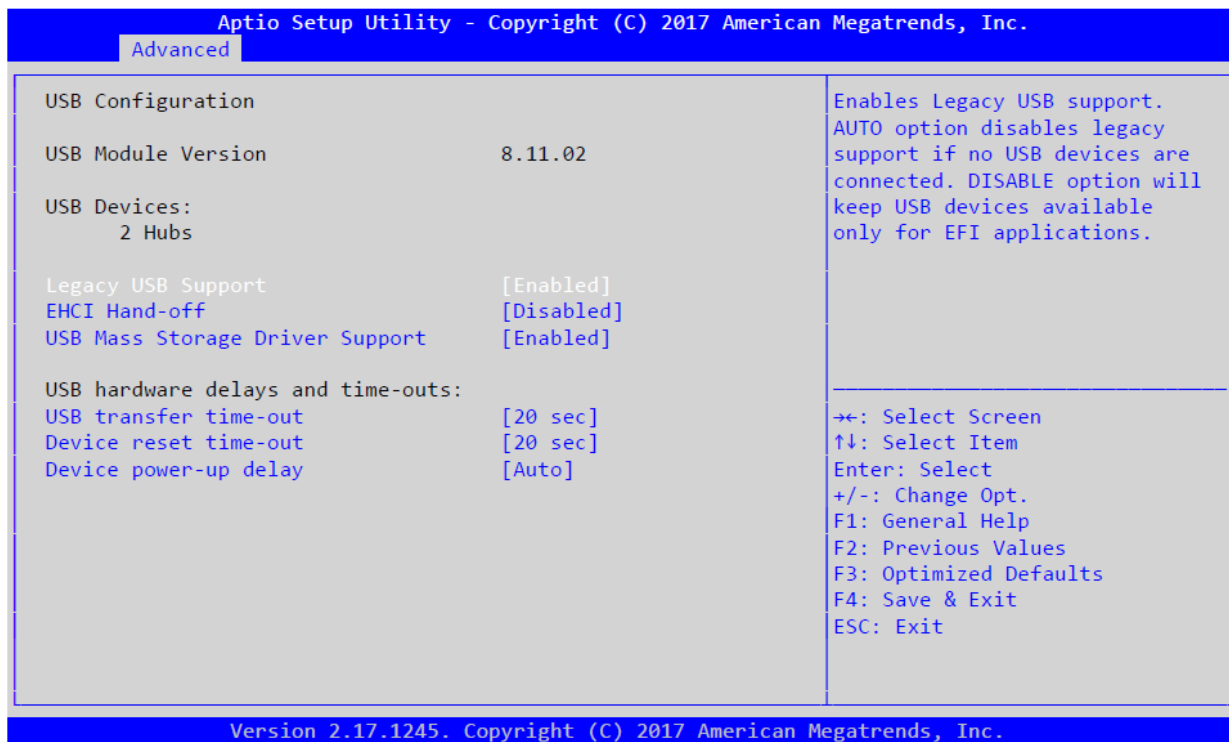

Figure 7- 15: Screen of the “USB Configuration” submenu

Where:

Legacy USB Support – Enabling/Disabling support of USB devices by BIOS:

[Enabled] – Enabled.

[Disabled] – Disabled.

[Auto] – Is automatically turned on when required.

XHCI Hand-off – Enabling/Disabling BIOS transfer of the control of XHCI controller of operating system:

[Upon Request] – Gate can be disabled by BIOS.

[Always] – Gate is always enabled.

Option ROM Messages – The mode for displaying Option ROM:

[Force BIOS] –Displaying information Option ROM is enabled.

[Keep Current] – Displaying information Option ROM is disabled.

Boot option filter – Boot mode filter:

[UEFI and Legacy] – Support of the both UEFI and Legacy boots.

[Legacy only] – Only Legacy boots are supported.

[UEFI only] – Only UEFI boots are supported.

Further, the settings of the Option ROM mode configuration (**Option ROM execution**) from various devices are shown (**Network** - network controllers, **Storage** - storage controllers, **Video** - video controllers, **Other PCI devices** - other PCI devices). Configuration is available for each device:

[Do not launch] – Do not launch the Option ROM for this type of device.

[UEFI] – Launch the Option ROM for this type of device in UEFI mode.

[Legacy] – Launch the Option ROM for this type of device in Legacy mode.

7.4 Chipset

In this tab, the south and north bridges integrated into the microprocessor are set. Figure 7-16 shows the Chipset tab menu.

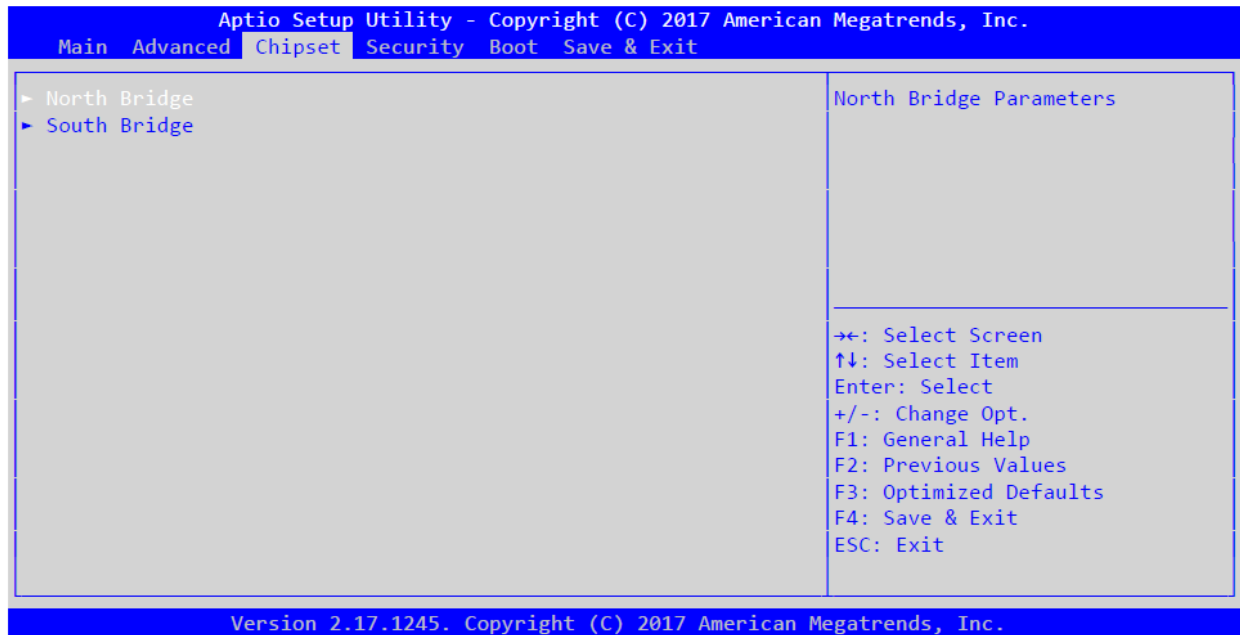

Figure 7- 16: Screen of the “Chipset” menu tab

Menu of this tab has two additional submenus, configuration of the “North Bridge” and “South Bridge”.

7.4.1 North Bridge

This submenu is used for configuration of the north bridge and contains information on the installed RAM is displayed. The submenu is shown in Figure 7-17.

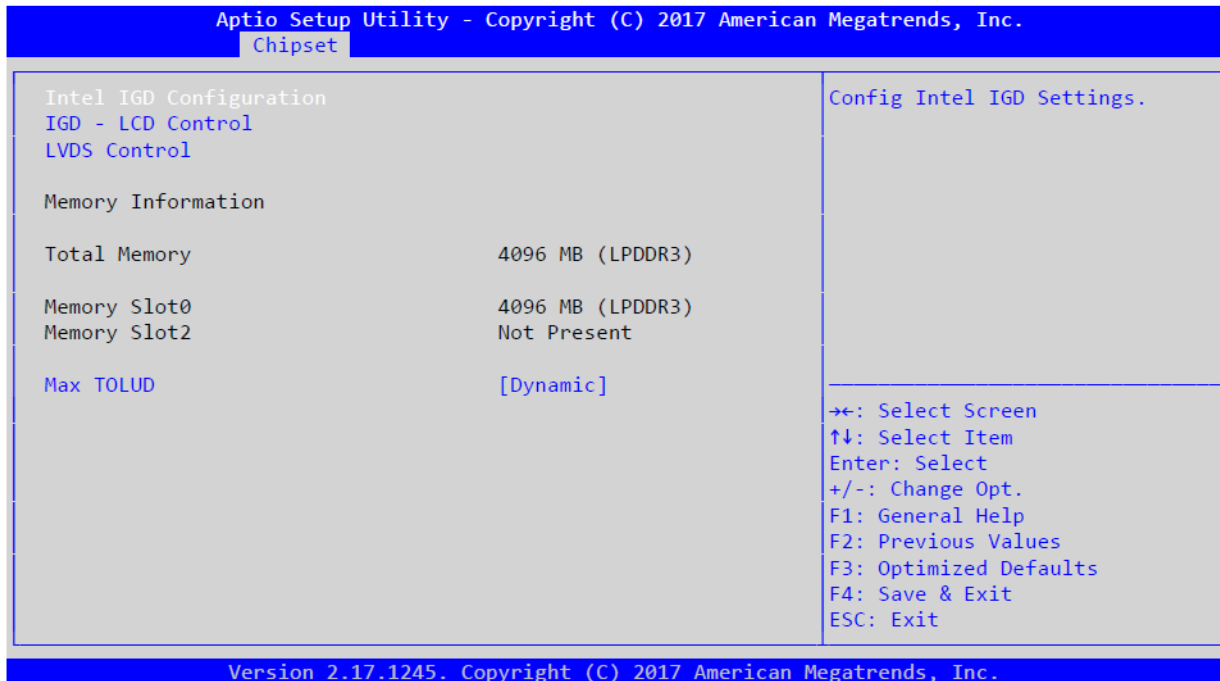

Figure 7- 17: Screen of the “North Bridge” submenu

Where:

Intel IGD Configuration – The submenu for configuration of the built-in Intel video adapter is activated (see subsection 7.4.2).

LVDS Control – The submenu for configuration of connecting LVDS panels to XP15, XP16 connectors is activated (see subsection 7.4.3).

Max TOLUD – Setting the maximum of the upper physical memory for use (more memory is assigned for PCI devices and Video):

[Dynamic] – TOLUD value is set automatically depending on the memory volume, occupied by external PCI devices and Video.

[2 GB ... 3 GB] – Setting the TOLUD value manually.

7.4.2 Intel IGD Configuration

This submenu is used for configuration of the integrated Intel video adapter. The submenu is shown in Figure 7- 18.

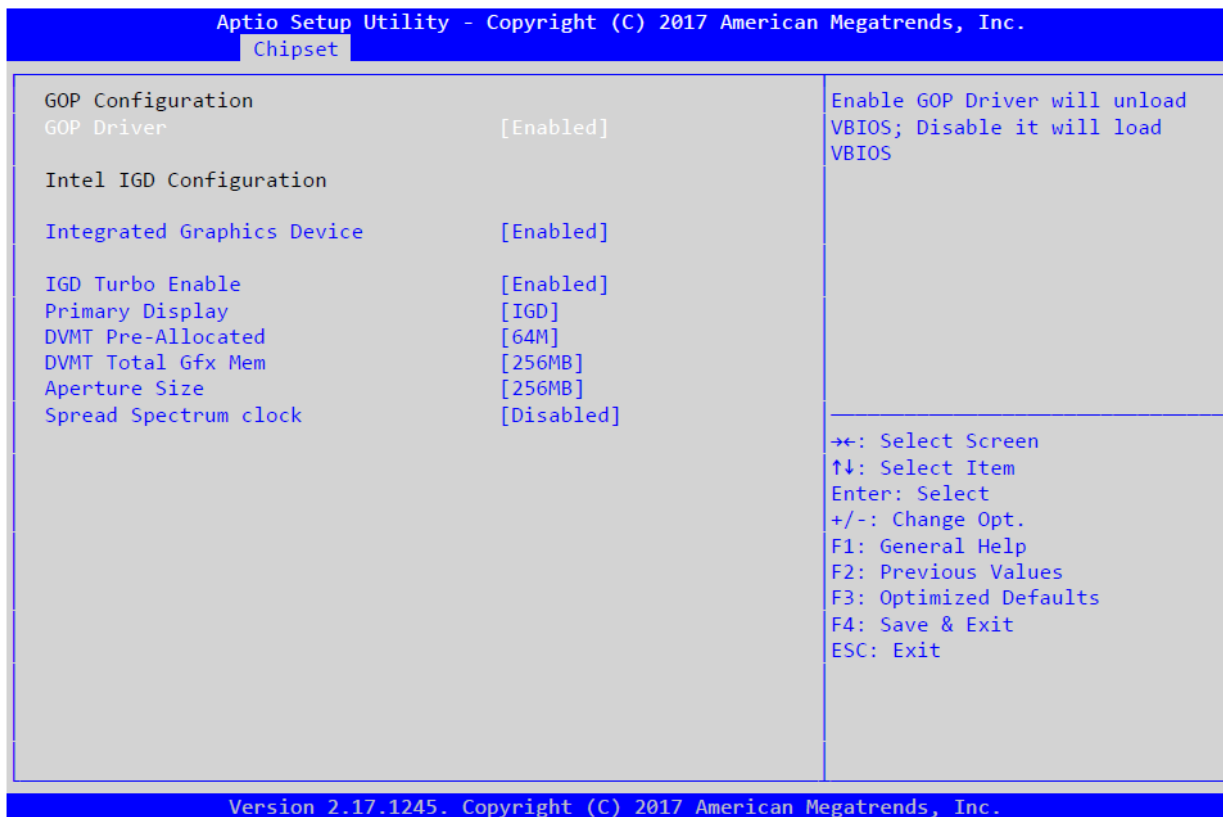

Figure 7- 18: Screen of the “Intel IGD Configuration” submenu

Where:

GOP Driver – Enables / disables the download of the GOP video driver instead of VBIOS at system startup:

[Enabled] – GOP driver is booted.

[Disabled] – VBIOS is booted.

Integrated Graphics Device – Enabling/disabling the built-in video adapter (IGD):

[Enabled] – IGD is enabled.

[Disabled] – IGD is disabled.

IGD Turbo Enable – Enabling/Disabling turbo mode (maximum frequency) of the built-in video adapter (IGD):

[Enabled] – Turbo mode is enabled.

[Disabled] – Turbo mode is disabled.

Primary Display – Selection of video adapter by default:

[Auto] – Automatic selection.

[IGD] –IGD built-in video adapter is selected.

[PCIe] – External video adapter on PCI Express bus is selected.

DVMT Pre-Allocated – Configuration of the fixed allocated volume of video memory from RAM for IGD:

[64M ... 512M] – Selection of video memory volume.

DVMT Total Gfx Mem – Configuration of the maximum dynamically allocated video memory volume from RAM:

[128MB, 256MB, Max] – Selection of 128 MB, 256 MB, maximum volume of RAM.

Aperture Size – Configuration of video memory volume allocated for textures:

[128MB ... 512MB] – Selection of video memory volume.

Spread Spectrum clock – Enabling/Disabling the mode of EMI level reduction from the built-in IGD video adapter:

[Enabled] – Enabled.

[Disabled] – Disabled.

7.4.3 LVDS Control

This submenu is used for configuration of connection of LVDS panels to XP14, XP19 connectors. The submenu is shown in Figure 7- 19.

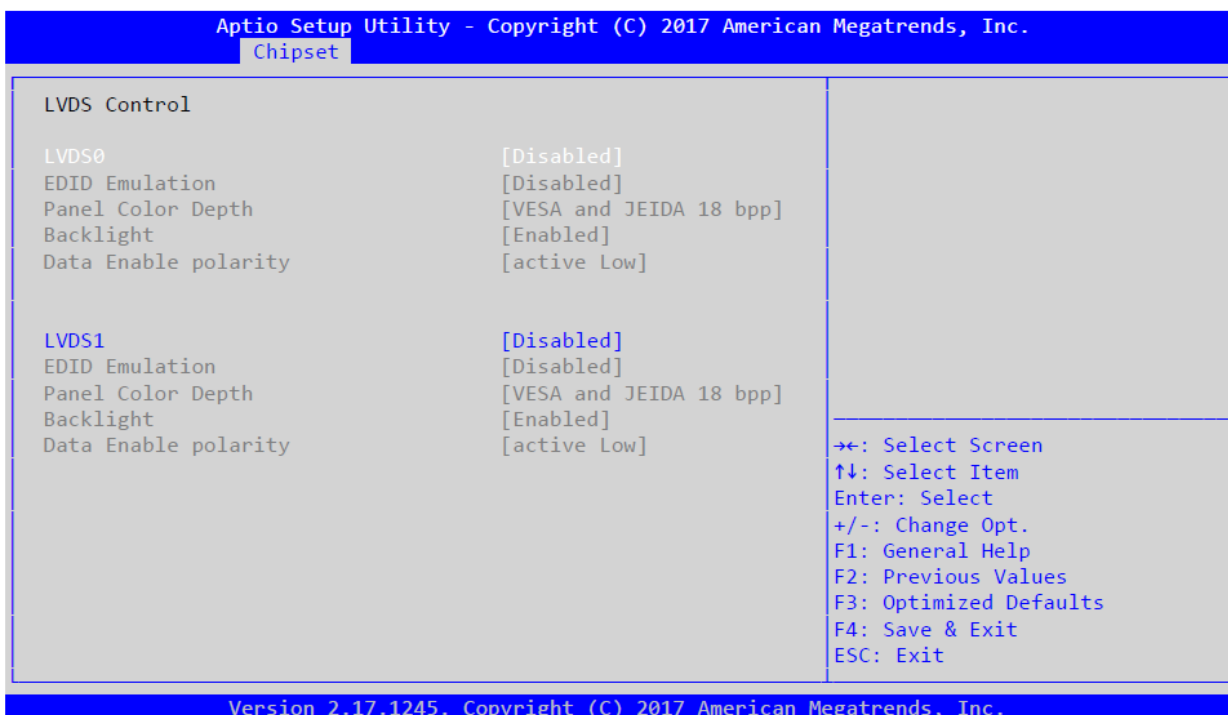

Figure 7- 19: Screen of the “LVDS Control” submenu

Connection of LVDS panels to XP14, XP19 connectors is configured separately and has a similar set of settings.

Configuration of connection of LVDS panel to XP19 connector becomes available when the relevant menu items “LVDS1 – XP16”, “LVDS0 – XP15” are set in the “Enabled” position. Below is the description of the set of settings for connection of LVDS panels to XP16, XP15 connectors, where:

EDID Emulation – Enabling and configuration of EDID emulation (monitor information):

[Disabled] – Disabled.

Panel Color Depth – Configuring color depth of the connected panel:

[VESA 24 bpp] – The connected panel has a 24 bit according to the VESA standard.

[JEIDA 24 bpp] – The connected panel has a 24 bit according to the JEIDA standard.

[VESA and JEIDA 18 bpp] – The connected panel has 18 bit.

Data Enable polarity – Indicates the polarity of the synchronization signals (HSYNC, VSYNC):

[active Low] – Active “0”.

[active High] – Active “1”.

7.4.4 South Bridge

Submenu for south bridge configuration. The submenu is shown in Figure 7- 20.

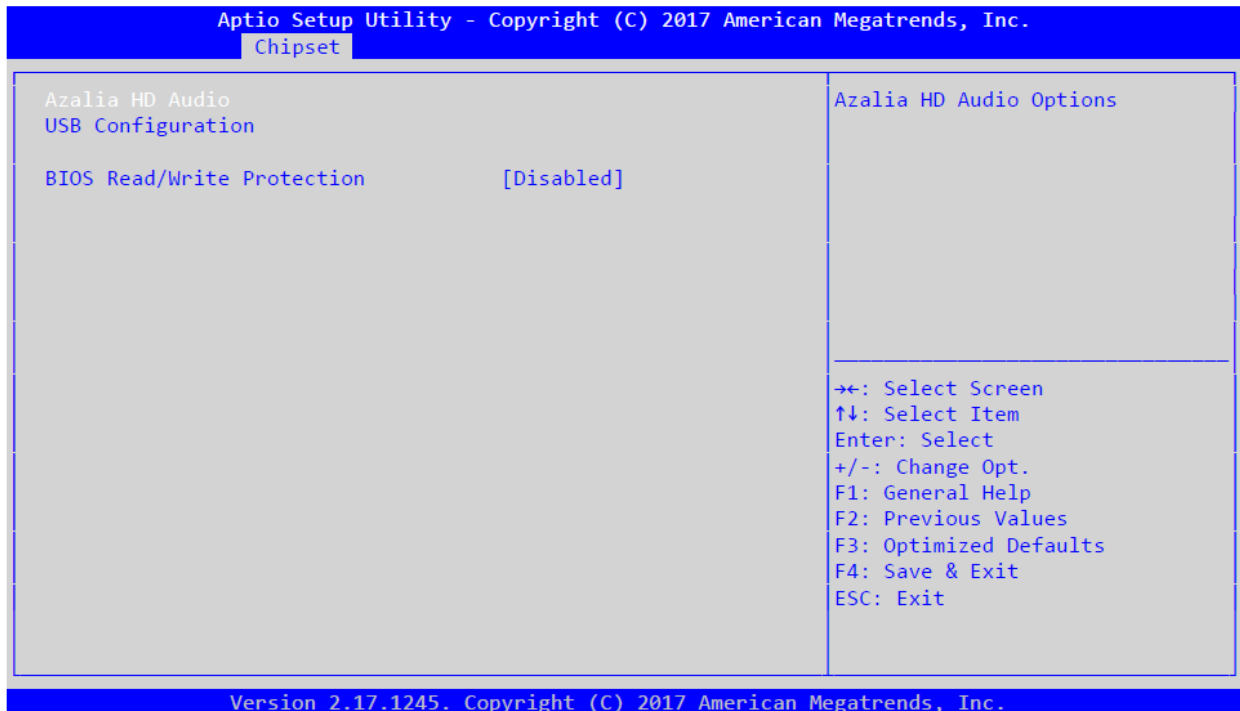

Figure 7- 20: Screen of the “South Bridge” submenu

Where:

Azalia HD Audio – The submenu for configuration of the built-in audio controller Azalia (see subsection 7.4.5) is activated.

USB Configuration – Submenu for configuration of USB-controller (see subsection 7.4.3) is activated.

BIOS Read/Write Protection – Enabling/disabling protection of the BIOS SPI area:

[Enabled] – Protection is enabled.

[Disabled] – Protection is disabled.

7.4.5 Azalia HD Audio

This submenu is used for configuration of the built-in audio controller Azalia. The submenu is shown in Figure 7- 21.

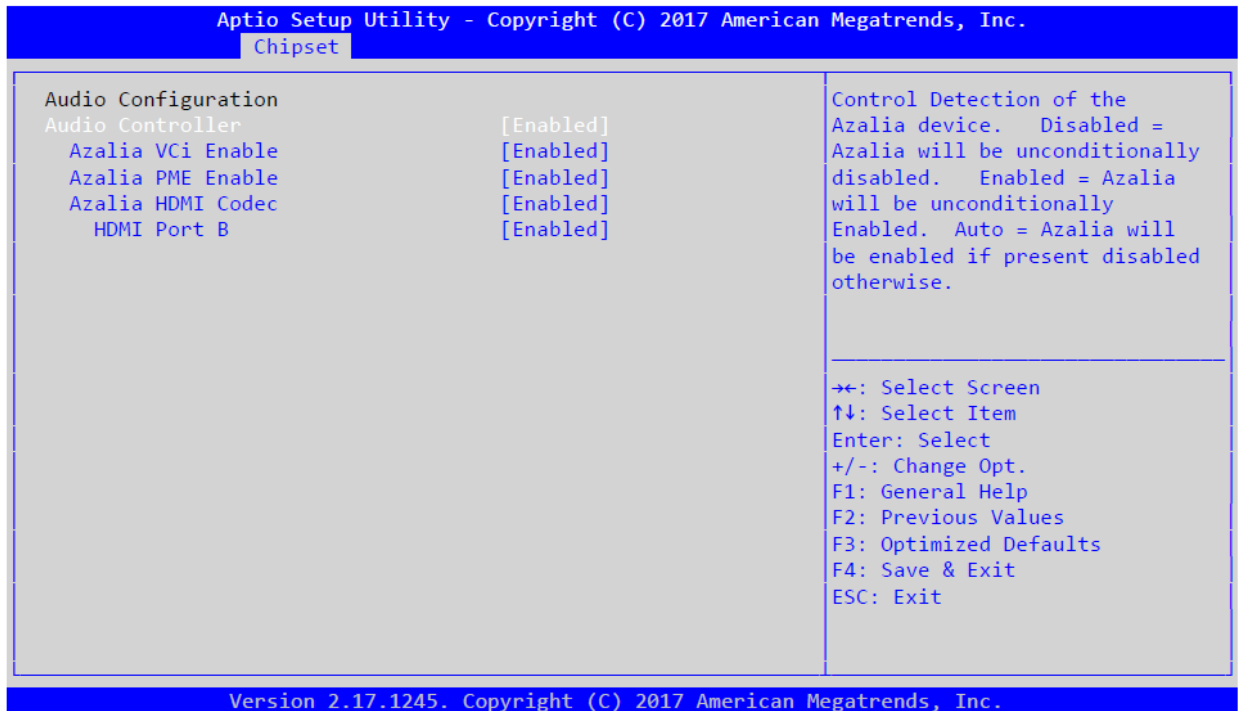

Figure 7- 21: Screen of the “Azalia HD Audio” submenu

Where:

Audio Controller – Enabling/disabling the built-in audio controller:

[Enabled] – Audio controller is enabled.

[Disabled] – Audio controller is disabled.

Azalia HDMI Codec – Enabling/disabling transfer of audio via digital interface of the monitor (DisplayPort):

[Enabled] – Enabled.

[Disabled] – Disabled.

7.4.6 USB Configuration

This submenu is used for configuration of USB controller. The submenu is shown in Figure 7-22.

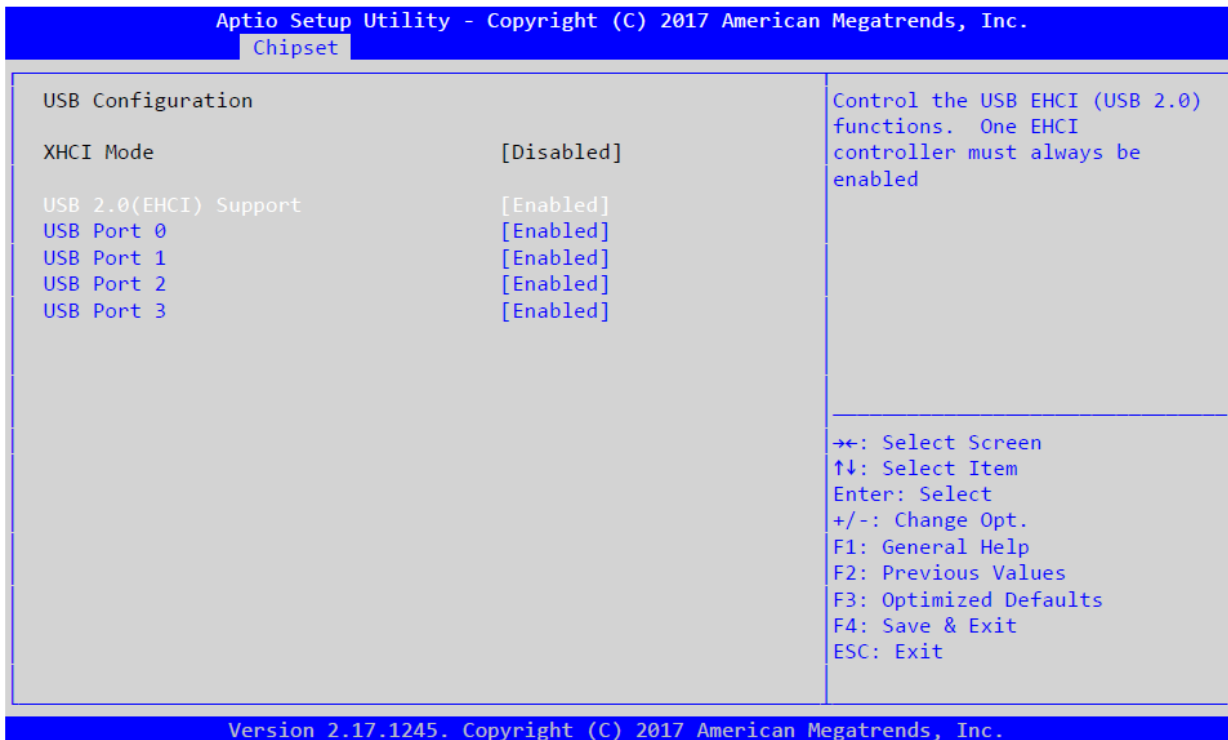

Figure 7- 22: Screen of the “USB Configuration” submenu

Where:

- XHCI Mode** – Enabling/disabling XHCI controller (available when EHCI controller is disabled):
 - [Enabled]** – XHCI controller is enabled.
 - [Disabled]** – XHCI controller is disabled.
- USB 2.0(EHCI) Support** – Enabling/disabling EHCI controller (available when XHCI controller is disabled):
 - [Enabled]** – XHCI controller is enabled.
 - [Disabled]** – XHCI controller is disabled.
- USB Port 0** – Enabling/disabling USB Port 0 (XP2 connector):
 - [Enabled]** – USB Port 0 is enabled.
 - [Disabled]** – USB Port 0 is disabled.
- USB Port 1** – Enabling/disabling USB Port 1 (XP2 connector):
 - [Enabled]** – USB Port 1 is enabled.
 - [Disabled]** – USB Port 1 is disabled.
- USB Port 2** – Enabling/disabling USB Port 2 (USB 2.0 mode at XP1 connector):
 - [Enabled]** – USB Port 2 is enabled.
 - [Disabled]** – USB Port 2 is disabled.
- USB Port 3** – Enabling/disabling USB Port 3 (USB 2.0 mode at XP1 connector):
 - [Enabled]** – USB Port 3 is enabled.
 - [Disabled]** – USB Port 3 is disabled.

7.5 Security

This tab is intended for configuring the module’s protection functions. The menu screen of this tab is shown in Figure 7-23.

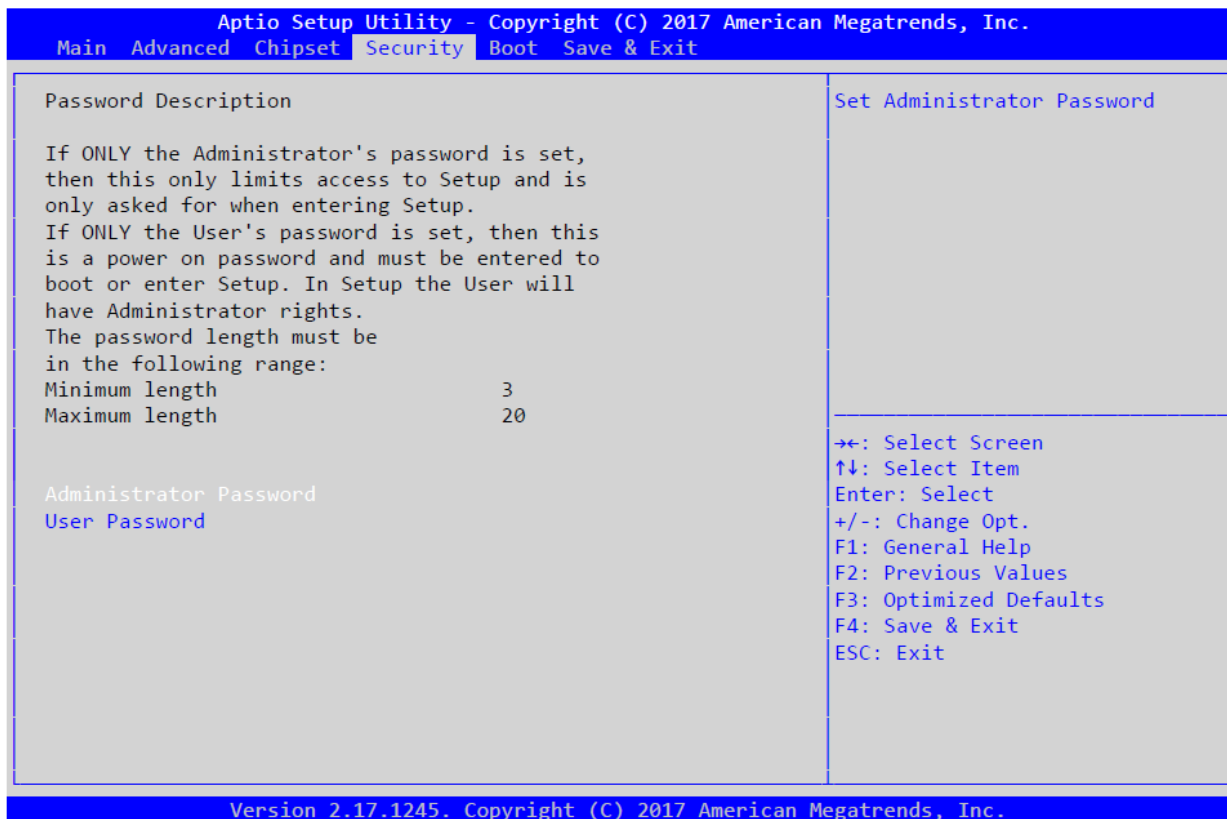

Figure 7- 23: Screen of the “Security” tab

Where:

Administrator Password: Setting a password to log in to BIOS Setup with Administrator permission.

User Password: Setting a password for booting the OS and to log in to BIOS Setup with user permission.

7.6 Boot

The tab for configuration of the boot mode and module load devices. The menu of this tab is shown in Figure 7-24.

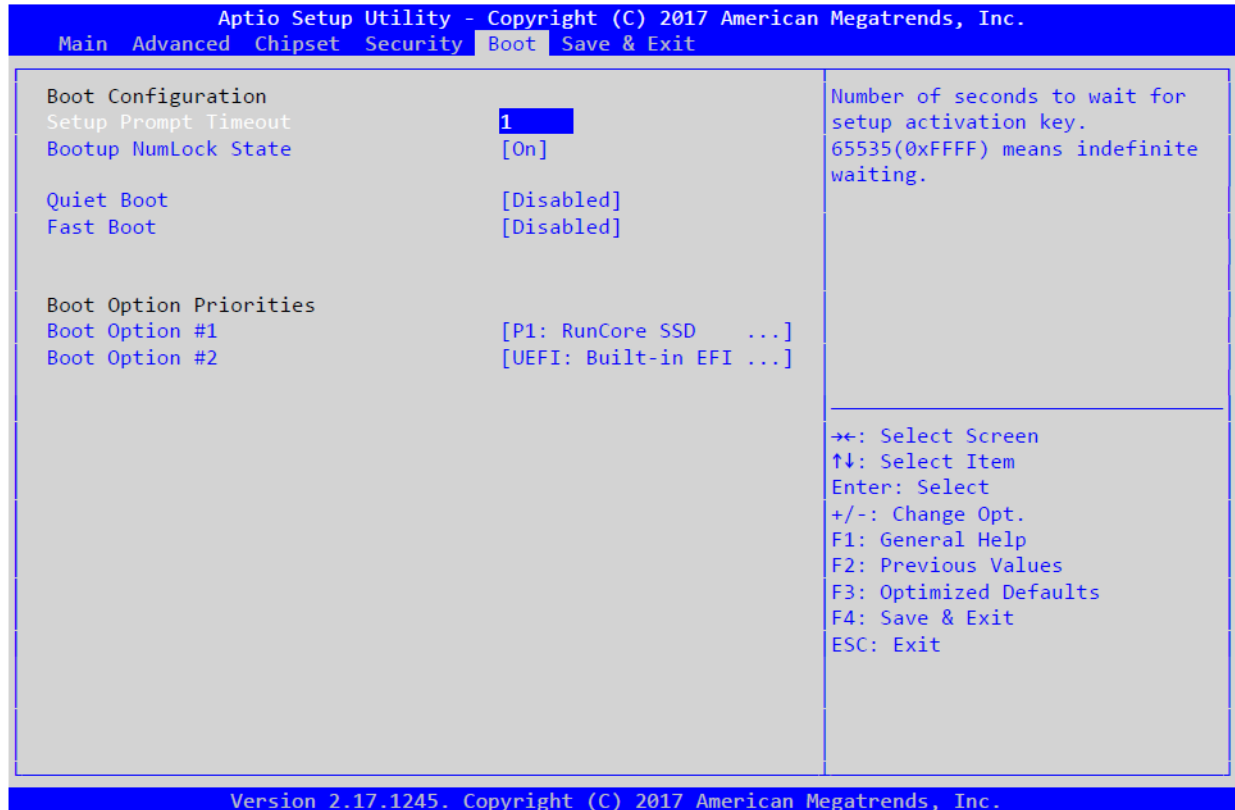

Figure 7- 24: Screen of the “Boot” menu tab

Where:

Setup Prompt Timeout: Setting the time (in seconds) for displaying invitation to enter the BIOS SETUP.

Bootup NumLock State: Default setting the "NumLock" LED on the keyboard at startup.

[On] – LED is on.

[Off] – LED is off.

Quiet Boot: Enabling/disabling the “quiet boot” mode, without displaying the BIOS information.

[Enabled] – Enabled.

[Disabled] – Disabled.

Fast Boot: Enabling/disabling the fast boot mode, with initialization of the minimum amount of devices.

[Enabled] – Enabled.

[Disabled] – Disabled.

Boot Option Priorities: This menu sets the OS boot priority from the devices (P1: Runcore SSD - Onboard NAND Flash integrated drive).

7.7 Save & Exit

The tab of parameters of BIOS Setup exit. The menu of this tab is shown in Fig. 7-25.

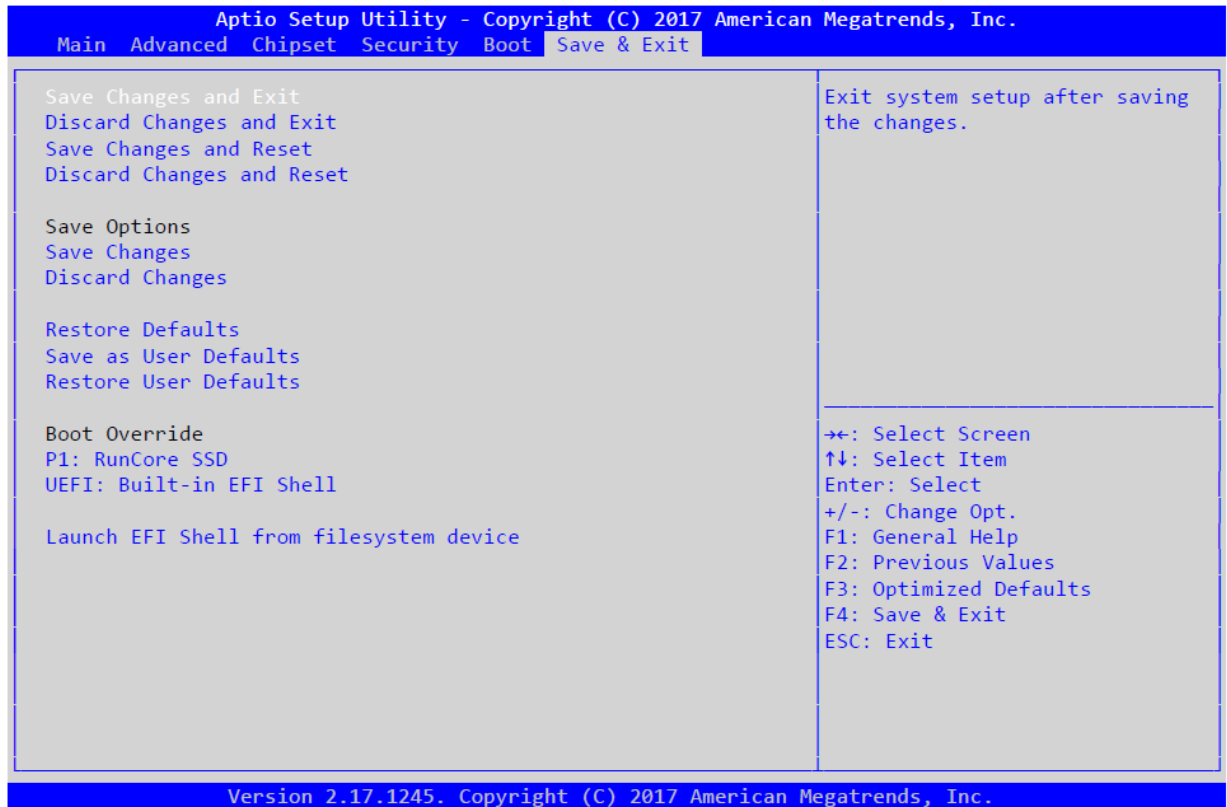

Figure 7- 25: Screen of the “Save & Exit” menu tab

Where:

Save Changes and Exit: Exit from BIOS Setup with the changed saved.

Discard Changes and Exit: Discarding changes and exit from BIOS Setup

Save Changes and Reset: Saving changes and restarting the system

Discard Changes and Exit: Discarding changes and restarting

Save Changes: Saving changes

Discard Changes: Discarding changes

Restore Defaults: Loading default settings made by the manufacturer.

Save as User Defaults: Saving the settings as made by the user.

Restore User Defaults: Loading user settings.

BOOT Override: this menu is used for the forced selection of the device to boot the OS promptly.

Launch EFI Shell from filesystem device: Launch of EFI console.

ANNEX B

DISCLAIMER

This Disclaimer contains special operating conditions of Fastwel in the following areas: intellectual property, warranty policy, conditions of the order and delivery.

1 INTELLECTUAL PRORETY

1.1 If any infraction, interference, improper use, illegitimate exploitation and/or violation of the industrial and/or intellectual property rights of any third party and/or property, exploitation during the use of Fastwel Embedded Module will take place – Fastwel does not guarantee to replace the materials, computer programs, procedures or equipment affected by the complaint and under no circumstances doesn't bear responsibility in any form for possible refusal in case of such a replacement.

1.2 Use of the Fastwel products as well as the objects of intellectual property containing in them, in the ways and for the purposes, not provided by the present user manual and datasheet isn't allowed without preliminary written approval of Fastwel.

1.3 Fastwel is not responsible for possible incidents and losses, related to the operation of end devices, in which the original Fastwel equipment is used.

2 WARRANTY POLICY

2.1 When the detected flaws in an element can be corrected without decreasing the foreseen technical features and functionality for it, User may demand Fastwel the urgent correction of the failures in additionally agreed period and an increasing of the period of the guarantee of the element equal as the time elapsed from the formal request to repair the failures, until the receipt of the repaired element. All costs associated to the correction of failures, included those of assembly, dismantle, transport, tests, etc, if they exist, shall be prosecuted according the Warranty Policy of Fastwel.

3 ORDER AND DELIVERY CONDITIONS

3.1 The general rule is that all Fastwel equipment prices are determined with due consideration of delivery under the EXW terms and conditions (Incoterms 2010). Delivery of the products under other terms and conditions should be preliminary agreed and stated in writing between the parties.

3.2 Unless otherwise expressly agreed with Fastwel, all the deliveries of Fastwel equipment will be carried out only after the official purchase order is obtained and provided that the ordered products have been prepaid in full. Other terms and conditions of cooperation should be made in writing.

3.3 Any delivery of Fastwel electronics is submitted with the right package in accordance with the current rules and standards in the Member States of the European Economic Area. The purchaser independently bears all risks regarding the compliance of package and marking of Fastwel products with legislation requirements being in effect at the place of purchased products destination (in the buyer's country). The specified condition excludes unequivocally any liability of Fastwel for possible non-compliance of package and marking of products with the requirements of legislation of the country of products destination.

3.4 In general, all components of the supply are properly protected with respect to freight, in order to avoid any damage to the supply, third parties, environmental damages or unrelated goods, as consequence of wrong packaging.

3.5 Each package unit is labeled on the exterior area with the indications of product's Part Number and Serial Number.

3.6 The support documents for the order should be made either in English or in Russian unless otherwise agreed between parties in writing.

3.7 Fastwel does not pay penalties and does not cover costs associated with delay in the delivery of the products caused by actions of the third parties, force-majeure etc. - Fastwel doesn't bear any responsibility for non-execution or inadequate execution of the obligations in a case when it is caused by actions of the third parties (for example producers or suppliers of accessories), force majeure etc.

3.8 Fastwel declares that independently and at any time without damage, it has an exclusive right to define and change functionality architecture, bill of materials of its products without any preliminary coordination and approvals of the third parties.

4 OTHER CONDITIONS

4.1 Fastwel has the obligation to respect the current Russian legislation (including, but not limited to environmental, labor, social laws) in each moment and to apply it to its embedded electronics considering all and each execution phase, that is to say, from the design until the commissioning and subsequent maintenance. In this regard Fastwel is not liable to the user or other persons in connection with possible changes of the company's rules (including, but not limited to warranty, ordering policy) caused by changes of the Russian legislation.

4.2 Unless otherwise expressly agreed in writing, Fastwel provides no training for assembly\installation\adjustment\operation of its equipment.